

Doodle, freehand design.

design Simone Micheli
terzani.com

TERZANI



Name
Doodle
wall sconce

Materials
brass

CE ENEC CB

Finishes | Code

-  nickel plated
OJ82A E7 C8
-  black nickel plated
OJ82A E9 C8
-  gold plated
OJ82A L6 C8
-  copper (may age naturally)
OJ82A L5 C8

Body

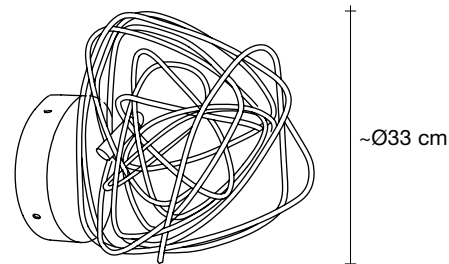

Light source
230-240V ~ 50/60Hz

 LED
2W G4 12V

dimming options

 not dimmable

 10-100kΩ
0/1-10V
PUSH
DALI

Canopy

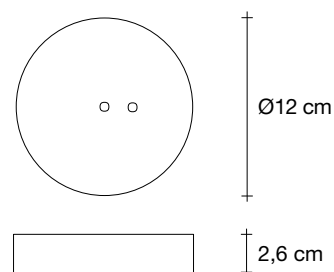

Canopy for DALI

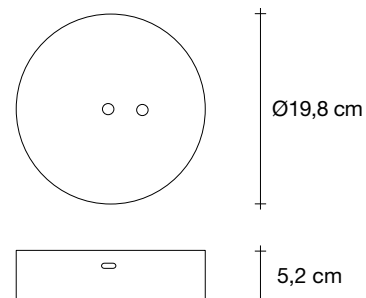

We no longer march in a straight line. Our lives are dynamic, intertwining collections of relationships, experiences, and journeys. Reflecting the fluidity of our generation, designer Simone Micheli has created a new, contemporary light for Terzani, Doodle. Like us, each Doodle is unique; each pendant is handcrafted by artisans to resemble a randomized path. And, to give us control over the journey we want to take, each led bulb can be placed anywhere on the light, not only reflecting the choices we make in life, but giving Doodle special flexibility. Available in nickel, black nickel, gold, and copper plated finishes. Design Simone Micheli.

Doodle, freehand design.

design Simone Micheli
terzani.com

TERZANI



Name
Doodle
pendant light

Materials
brass

CE ENEC CB

Finishes | Code

-  nickel plated
OJ80S E7 C8
-  black nickel plated
OJ80S E9 C8
-  gold plated
OJ80S L6 C8
-  copper (may age naturally)
OJ80S L5 C8

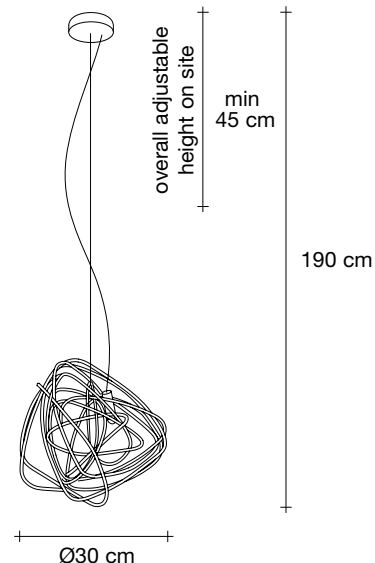

Body



Light source
230-240V ~ 50/60Hz

 LED
2W G4 12V

dimming options

-  not dimmable
-  10-100kΩ
0/1-10V
PUSH
DALI

Canopy | white

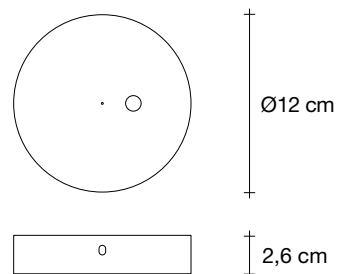

Canopy for DALI | white

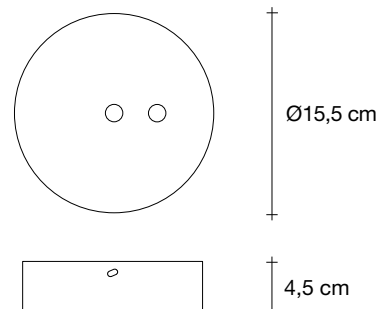

We no longer march in a straight line. Our lives are dynamic, intertwining collections of relationships, experiences, and journeys. Reflecting the fluidity of our generation, designer Simone Micheli has created a new, contemporary light for Terzani, Doodle. Like us, each Doodle is unique; each pendant is handcrafted by artisans to resemble a randomized path. And, to give us control over the journey we want to take, each led bulb can be placed anywhere on the light, not only reflecting the choices we make in life, but giving Doodle special flexibility. Available in nickel, black nickel, gold, and copper plated finishes. Design Simone Micheli.

Doodle, freehand design.

design Simone Micheli
terzani.com

TERZANI



Name
Doodle
chandelier

Materials
brass

CE ENEC CB

Finishes | Code

-  nickel plated
0J93S E7 C8
-  black nickel plated
0J93S E9 C8
-  gold plated
0J93S L6 C8

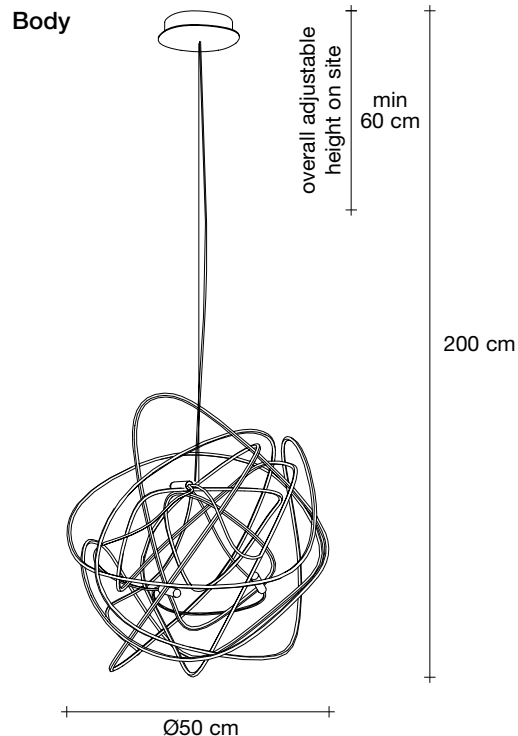

Light source
230-240V ~ 50/60Hz

 LED
5 x 2W G4 12V

dimnable options

 IGBT
DALI
1-10V
PWM

Canopy | white

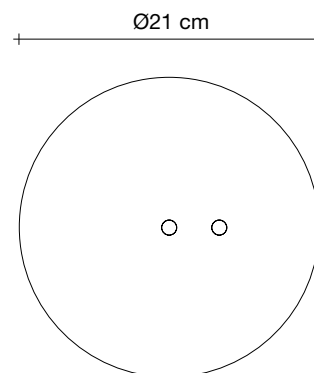

We no longer march in a straight line. Our lives are dynamic, intertwining collections of relationships, experiences, and journeys. Reflecting the fluidity of our generation, designer Simone Micheli has created a new, contemporary light for Terzani, Doodle. Like us, each Doodle is unique; each pendant is handcrafted by artisans to resemble a randomized path. And, to give us control over the journey we want to take, each led bulb can be placed anywhere on the light, not only reflecting the choices we make in life, but giving Doodle special flexibility. Available in nickel, black nickel, gold, and copper plated finishes. Design Simone Micheli.

Doodle, freehand *design.*

design Simone Micheli
terzani.com

TERZANI



Name
Doodle
table lamp

Materials
brass



Finishes | Code

-  nickel plated
0J84B E7 C8
-  black nickel plated
0J84B E9 C8
-  gold plated
0J84B L6 C8
-  copper (may age naturally)
0J84B L5 C8

Body

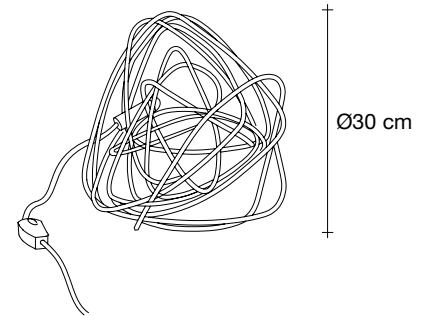

Light source
230-240V ~ 50/60Hz



 not dimmable

We no longer march in a straight line. Our lives are dynamic, intertwining collections of relationships, experiences, and journeys. Reflecting the fluidity of our generation, designer Simone Micheli has created a new, contemporary light for Terzani, Doodle. Like us, each Doodle is unique; each pendant is handcrafted by artisans to resemble a randomized path. And, to give us control over the journey we want to take, each led bulb can be placed anywhere on the light, not only reflecting the choices we make in life, but giving Doodle special flexibility. Available in nickel, black nickel, gold, and copper plated finishes. Design Simone Micheli.

Doodle, freehand design.

design Simone Micheli
terzani.com

TERZANI







Name
Doodle
linear chandelier

Materials
brass

CE ENEC CB

Finishes | Code

-  nickel plated
OJ81S E7 C8
-  black nickel plated
OJ81S E9 C8
-  gold plated
OJ81S L6 C8
-  copper (may age naturally)
OJ81S L5 C8

Body

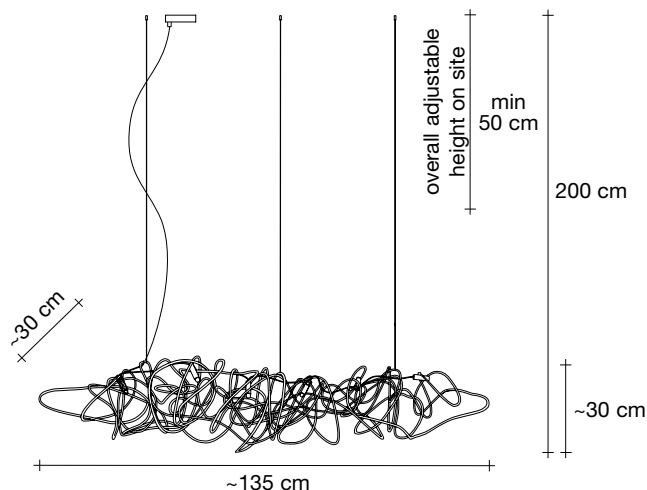

Light source
230-240V ~ 50/60Hz

 LED
6 x 2W G4 12V

dimnable options

 IGBT
DALI
1-10V
PWM

Canopy

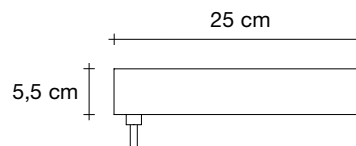

Canopy for DALI

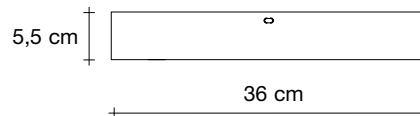

We no longer march in a straight line. Our lives are dynamic, intertwining collections of relationships, experiences, and journeys. Reflecting the fluidity of our generation, designer Simone Micheli has created a new, contemporary light for Terzani, Doodle. Like us, each Doodle is unique; each pendant is handcrafted by artisans to resemble a randomized path. And, to give us control over the journey we want to take, each led bulb can be placed anywhere on the light, not only reflecting the choices we make in life, but giving Doodle special flexibility. Available in nickel, black nickel, gold, and copper plated finishes. Design Simone Micheli.

Doodle, freehand design.

design Simone Micheli
terzani.com

TERZANI



Name
Doodle
vertical chandelier

Materials
brass

CE ENEC CB

Finishes | Code

-  nickel plated
OJ87S E7 C8
-  black nickel plated
OJ87S E9 C8
-  gold plated
OJ87S L6 C8
-  copper (may age naturally)
OJ87S L5 C8

Body

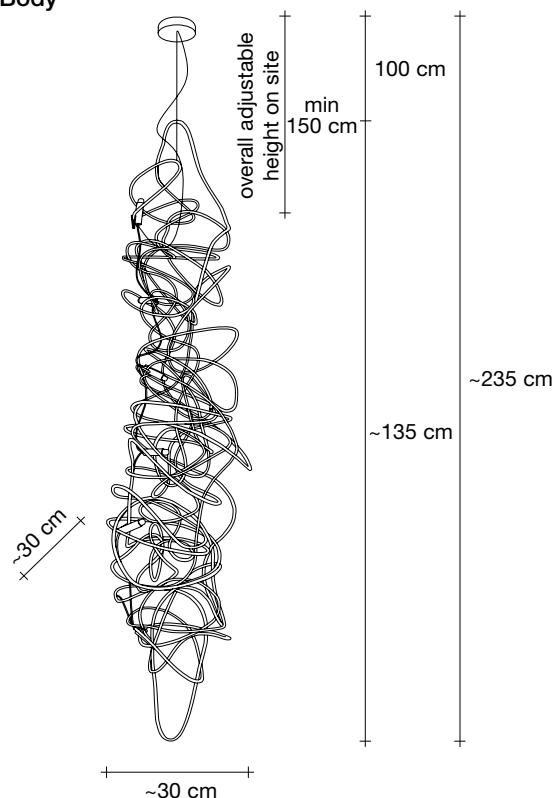

Light source
230-240V ~ 50/60Hz

 LED
6 x 2W G4 12V

dimnable options

 IGBT
DALI
1-10V
PWM

Canopy | white

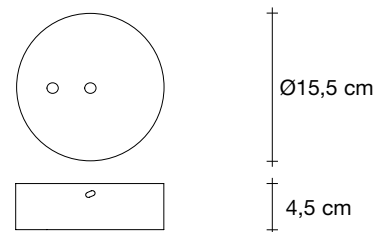

Canopy for DALI | white

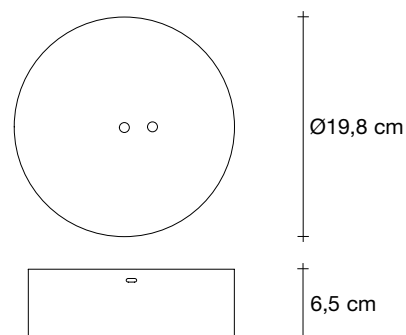

We no longer march in a straight line. Our lives are dynamic, intertwining collections of relationships, experiences, and journeys. Reflecting the fluidity of our generation, designer Simone Micheli has created a new, contemporary light for Terzani, Doodle. Like us, each Doodle is unique; each pendant is handcrafted by artisans to resemble a randomized path. And, to give us control over the journey we want to take, each led bulb can be placed anywhere on the light, not only reflecting the choices we make in life, but giving Doodle special flexibility. Available in nickel, black nickel, gold, and copper plated finishes. Design Simone Micheli.

Doodle, freehand *design.*

design Simone Micheli
terzani.com

TERZANI



Name
Doodle
floor lamp

Materials
brass



Finishes | Code

-  nickel plated
OJ86P E7 C8
-  black nickel plated
OJ86P E9 C8
-  gold plated
OJ86P L6 C8
-  copper (may age naturally)
OJ86P L5 C8

Body

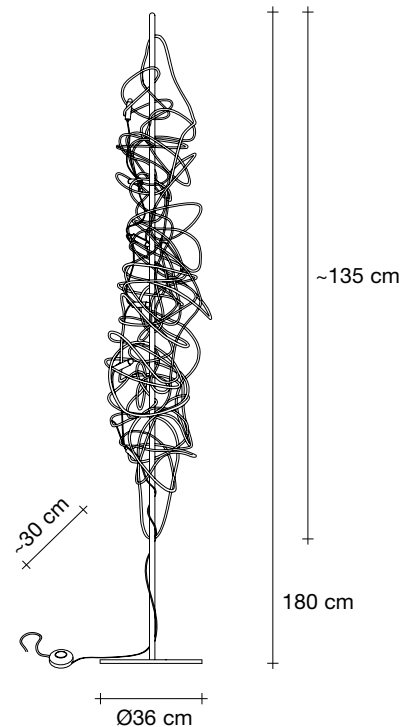

Light source

230-240V ~ 50/60Hz

 LED
6 x 1.2W G4 12V

 not dimmable

We no longer march in a straight line. Our lives are dynamic, intertwining collections of relationships, experiences, and journeys. Reflecting the fluidity of our generation, designer Simone Micheli has created a new, contemporary light for Terzani, Doodle. Like us, each Doodle is unique; each pendant is handcrafted by artisans to resemble a randomized path. And, to give us control over the journey we want to take, each led bulb can be placed anywhere on the light, not only reflecting the choices we make in life, but giving Doodle special flexibility. Available in nickel, black nickel, gold, and copper plated finishes. Design Simone Micheli.