

# Calle, perennial *elegance.*

design Draw  
terzani.com

# TERZANI



### Name

Calle  
pendant light

### Materials

clear crystal (24% lead)

### Finishes | Code



white disc | clear  
OT01S E8 A9 KK

### Body

NO DRIVER INCLUDED

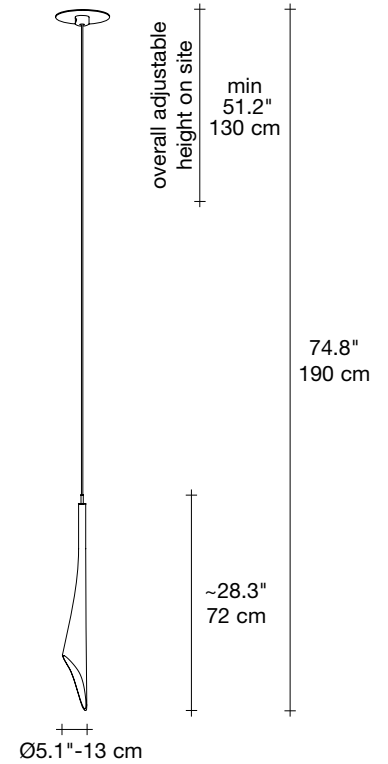

### Light source options

12V ~ 50/60Hz



XENON BI-PIN T3  
20W G4 12V

or



LED  
2W G4 12V

dimnable drivers available



ELV

### Disc

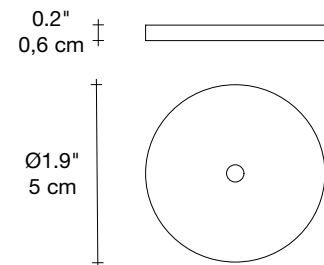

At Terzani, we spend countless days searching the globe for talented new designers, but sometimes they find us. Such is the case with the young designers Luca Martorano and Mattia Albicini (Draw), who approached us with the design for Calle, a fantastic new light we instantly fell in love with. It showcases our skill at crafting crystal, taking the material to an exciting, modern place. Luca and Mattia worked with our craftsmen to create a slender inverted flute of crystal that, like the calla lily it mimics, can be grouped into stunning bouquets of light. Design Draw.



3.3 lbs

1,5 kg



6.6 lbs

3 kg



32.7" × 9.8" × 10.2"

83 × 25 × 26 cm

# Calle, perennial *elegance.*

design Draw  
terzani.com

# TERZANI



### Name

Calle  
pendant light

### Materials

clear crystal (24% lead)



### Finishes | Code



clear  
OT01S E8 A9

### Body

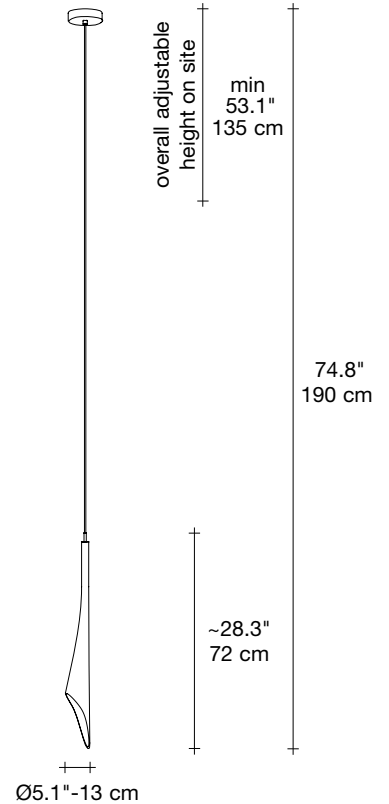

### Light source options

120V ~ 50/60Hz



XENON BI-PIN T3  
20W G4 12V

or



LED  
2W G4 12V

### dimnable options



ELV

### Canopy | white

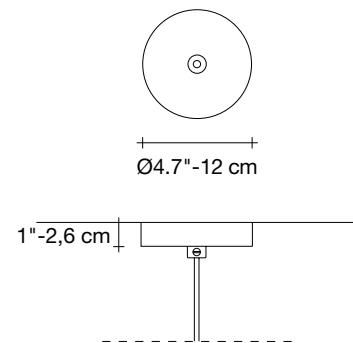

At Terzani, we spend countless days searching the globe for talented new designers, but sometimes they find us. Such is the case with the young designers Luca Martorano and Mattia Albicini (Draw), who approached us with the design for Calle, a fantastic new light we instantly fell in love with. It showcases our skill at crafting crystal, taking the material to an exciting, modern place. Luca and Mattia worked with our craftsmen to create a slender inverted flute of crystal that, like the calla lily it mimics, can be grouped into stunning bouquets of light. Design Draw.



3.3 lbs

1,5 kg



6.6 lbs

3 kg



32.7" x 9.8" x 10.2"

83 x 25 x 26 cm

# Calle, perennial *elegance.*

design Draw  
terzani.com

# TERZANI



**Name**  
Calle  
3 round multi light pendant

**Materials**  
clear crystal (24% lead)



**Finishes | Code**

 clear  
OT03S E8 A9

**Body**

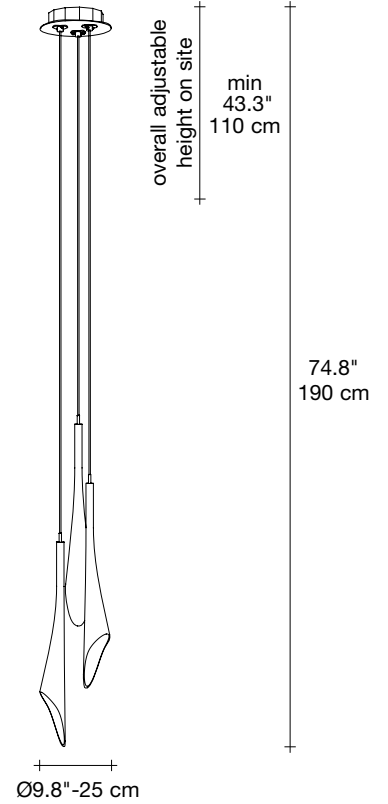

**Light source options**

**120V ~ 50/60Hz**

 XENON BI-PIN T3  
3 × 20W G4 12V

or

 LED  
3 × 2W G4 12V

**dimnable options**

 ELV

**Canopy | white**

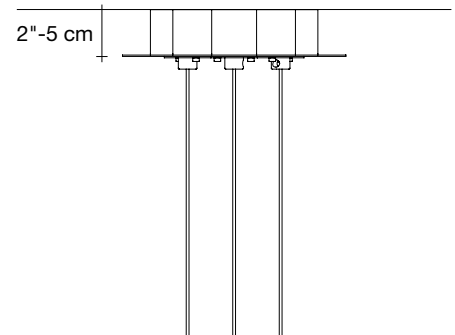
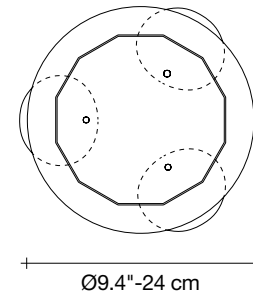

At Terzani, we spend countless days searching the globe for talented new designers, but sometimes they find us. Such is the case with the young designers Luca Martorano and Mattia Albicini (Draw), who approached us with the design for Calle, a fantastic new light we instantly fell in love with. It showcases our skill at crafting crystal, taking the material to an exciting, modern place. Luca and Mattia worked with our craftsmen to create a slender inverted flute of crystal that, like the calla lily it mimics, can be grouped into stunning bouquets of light. Design Draw.

v1.1

 13.2 lbs  
6 kg

 22 lbs  
10 kg

 30.3" × 30.3" × 11.8"  
77 × 77 × 30 cm

# Calle, perennial *elegance.*

design Draw  
terzani.com

# TERZANI



**Name**  
Calle  
3 linear multi light pendant

**Materials**  
clear crystal (24% lead)



**Finishes | Code**

 clear  
OT03S E8 A9 R

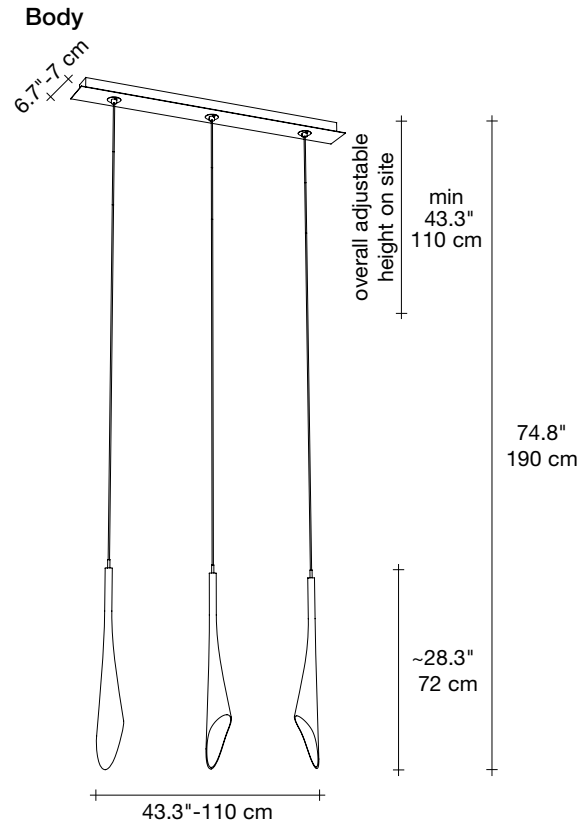

**Light source options**

**120V ~ 50/60Hz**

 XENON BI-PIN T3  
3 x 20W G4 12V

or

 LED  
3 x 2W G4 12V



**dimnable options**



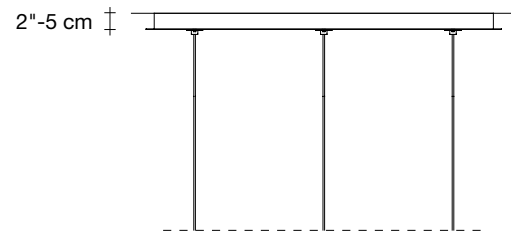
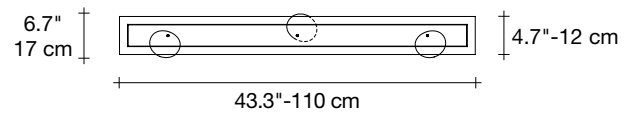

 ELV





**Canopy | white**



At Terzani, we spend countless days searching the globe for talented new designers, but sometimes they find us. Such is the case with the young designers Luca Martorano and Mattia Albicini (Draw), who approached us with the design for Calle, a fantastic new light we instantly fell in love with. It showcases our skill at crafting crystal, taking the material to an exciting, modern place. Luca and Mattia worked with our craftsmen to create a slender inverted flute of crystal that, like the calla lily it mimics, can be grouped into stunning bouquets of light. Design Draw.

 19.8 lbs  
 9 kg

 1x 14.3 lbs  
 1x 15.4 lbs  
 1x 6,5 kg  
 1x 7 kg

 1x 46" x 11.4" x 6.3"  
 1x 31.1" x 15" x 19.3"  
 1x 117 x 29 x 16 cm  
 1x 79 x 38 x 49 cm

# Calle, perennial *elegance.*

design Draw  
terzani.com

# TERZANI



**Name**  
Calle  
5 round multi light pendant

**Materials**  
clear crystal (24% lead)



**Finishes | Code**

 clear  
OT05S E8 A9

**Body**

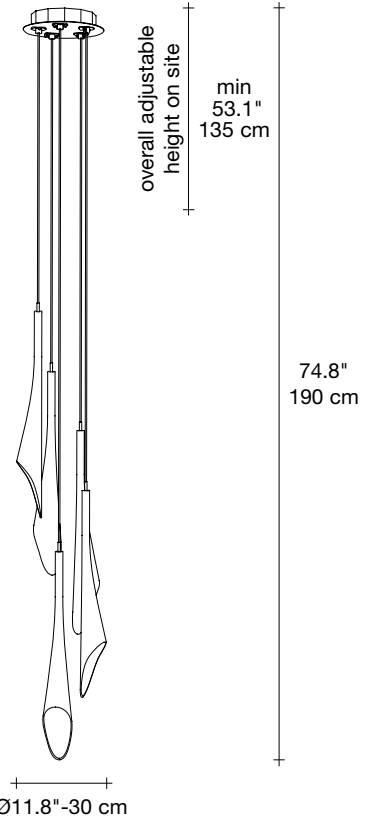

**Light source options**

**120V ~ 50/60Hz**

 XENON BI-PIN T3  
5 × 20W G4 12V

or

 LED  
5 × 2W G4 12V

**dimnable options**

 ELV

**Canopy | white**

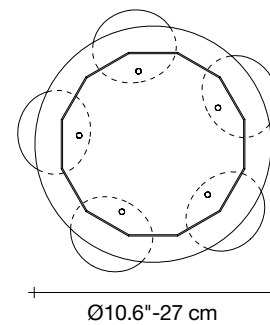

At Terzani, we spend countless days searching the globe for talented new designers, but sometimes they find us. Such is the case with the young designers Luca Martorano and Mattia Albicini (Draw), who approached us with the design for Calle, a fantastic new light we instantly fell in love with. It showcases our skill at crafting crystal, taking the material to an exciting, modern place. Luca and Mattia worked with our craftsmen to create a slender inverted flute of crystal that, like the calla lily it mimics, can be grouped into stunning bouquets of light. Design Draw.

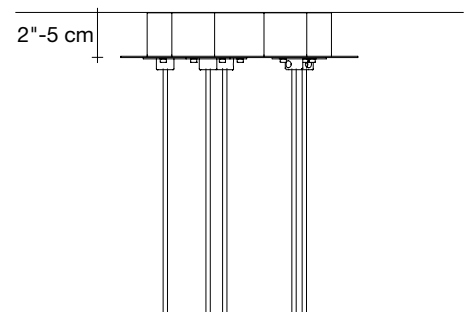

# Calle, perennial *elegance.*

design Draw  
terzani.com

# TERZANI



**Name**  
Calle  
5 linear multi light pendant

**Materials**  
clear crystal (24% lead)



**Finishes | Code**

 clear  
OT05S E8 A9 R

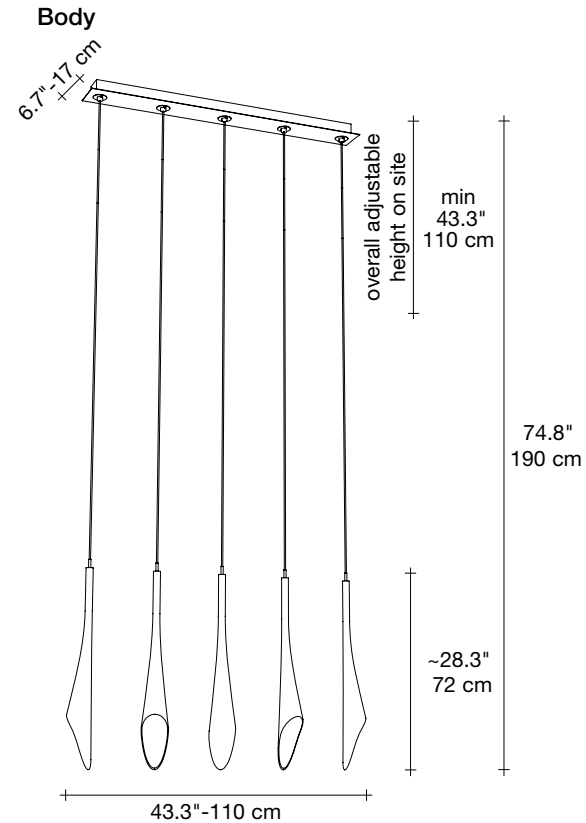

**Light source options**

**120V ~ 50/60Hz**

 XENON BI-PIN T3  
5 x 20W G4 12V

or

 LED  
5 x 2W G4 12V







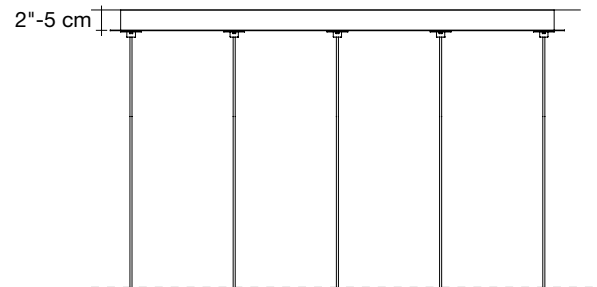
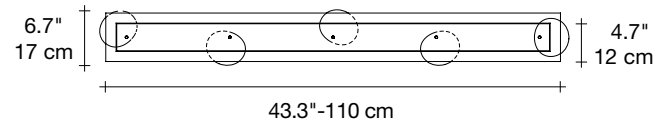



**dimmable options**

 ELV

**Canopy | white**



At Terzani, we spend countless days searching the globe for talented new designers, but sometimes they find us. Such is the case with the young designers Luca Martorano and Mattia Albicini (Draw), who approached us with the design for Calle, a fantastic new light we instantly fell in love with. It showcases our skill at crafting crystal, taking the material to an exciting, modern place. Luca and Mattia worked with our craftsmen to create a slender inverted flute of crystal that, like the calla lily it mimics, can be grouped into stunning bouquets of light. Design Draw.

 27.5 lbs	 1x 14.3 lbs	 1x 46" x 11.4" x 6.3"
 12,5 kg	 1x 25.3 lbs	 1x 30.3" x 30.3" x 11.8"
	 1x 6,5 kg	 1x 117 x 29 x 16 cm
	 1x 11,5 kg	 1x 77 x 77 x 30 cm