

# Calle, perennial *elegance.*

design Draw  
terzani.com

## TERZANI



**Name**  
Calle  
pendant light

**Materials**  
clear crystal

CE ENEC CB

**Finishes | Code**

 white disc | clear  
OT01SE8A9KK

**Body**

DRIVER NOT INCLUDED

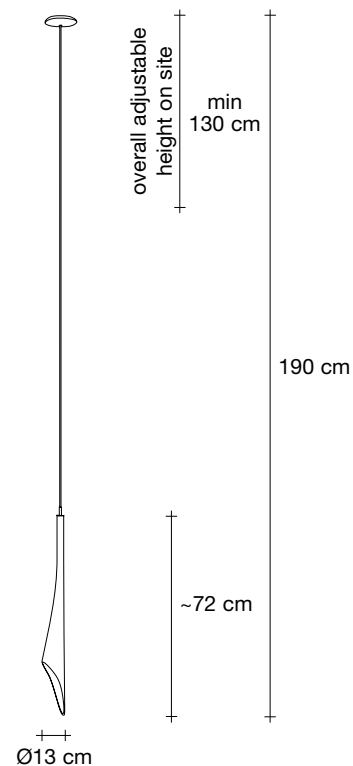

**Light source options**

12V ~ 50/60Hz

 halogen  
20W G4 12V

or

 led  
2W G4 12V

dimnable drivers available

 IGBT  
100kΩ  
0/1-10V  
PUSH  
DALI

**Disc | white**

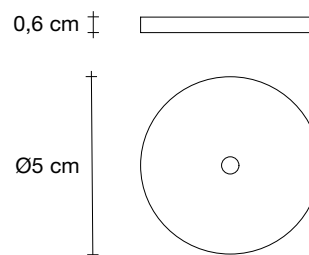

At Terzani, we spend countless days searching the globe for talented new designers, but sometimes they find us. Such is the case with the young designers Luca Martorano and Mattia Albicini (Draw), who approached us with the design for Calle, a fantastic new light we instantly fell in love with. It showcases our skill at crafting crystal, taking the material to an exciting, modern place. Luca and Mattia worked with our craftsmen to create a slender inverted flute of crystal that, like the calla lily it mimics, can be grouped into stunning bouquets of light. Design Draw.

# Calle, perennial *elegance.*

design Draw  
terzani.com

# TERZANI



**Name**  
Calle  
pendant light

**Materials**  
clear crystal

CE ENEC CB

**Finishes | Code**

 clear  
OT01SE8A9

**Body**

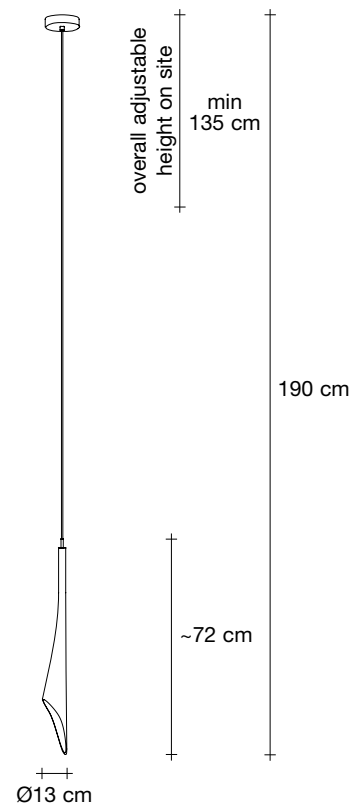

**Light source options**

230-240V ~ 50/60Hz

 halogen  
20W G4 12V

or

 led  
2W G4 12V

**dimnable options**

 not dimmable

 IGBT  
TRIAC  
DALI

**Canopy | white**

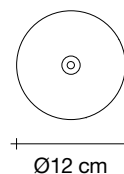

**Canopy for DALI | white**

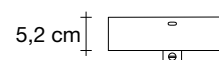
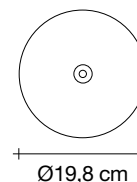

At Terzani, we spend countless days searching the globe for talented new designers, but sometimes they find us. Such is the case with the young designers Luca Martorano and Mattia Albicini (Draw), who approached us with the design for Calle, a fantastic new light we instantly fell in love with. It showcases our skill at crafting crystal, taking the material to an exciting, modern place. Luca and Mattia worked with our craftsmen to create a slender inverted flute of crystal that, like the calla lily it mimics, can be grouped into stunning bouquets of light. Design Draw.

# Calle, perennial *elegance.*

design Draw  
terzani.com

## TERZANI



**Name**  
Calle  
3 round multi light pendant

**Materials**  
clear crystal

CE ENEC CB

**Finishes | Code**

 clear  
OT03SE8A9

**Body**

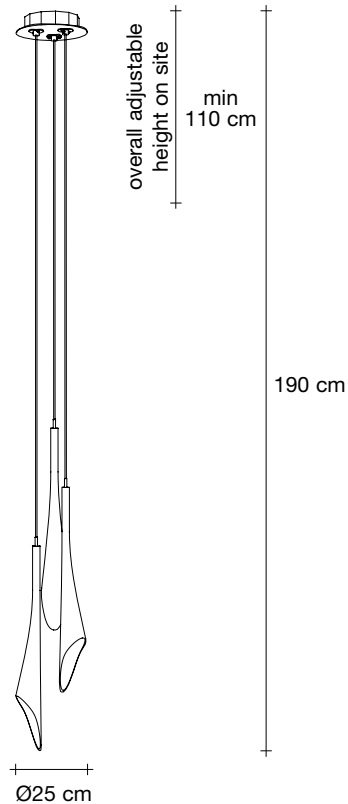

**Light source options**

230-240V ~ 50/60Hz

 halogen  
3 × 20W G4 12V

or

 led  
3 × 2W G4 12V

**dimming options**

 not dimmable

 IGBT  
DALI

**Canopy | white**

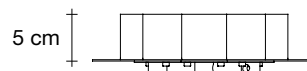
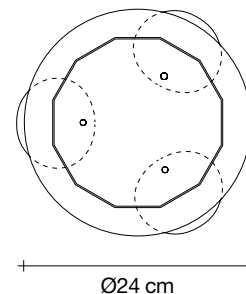

At Terzani, we spend countless days searching the globe for talented new designers, but sometimes they find us. Such is the case with the young designers Luca Martorano and Mattia Albicini (Draw), who approached us with the design for Calle, a fantastic new light we instantly fell in love with. It showcases our skill at crafting crystal, taking the material to an exciting, modern place. Luca and Mattia worked with our craftsmen to create a slender inverted flute of crystal that, like the calla lily it mimics, can be grouped into stunning bouquets of light. Design Draw.

# Calle, perennial *elegance.*

design Draw  
terzani.com

# TERZANI



**Name**  
Calle  
3 linear multi light pendant

**Materials**  
clear crystal

CE ENEC CB

**Finishes | Code**

 clear  
OT03SE8A9R

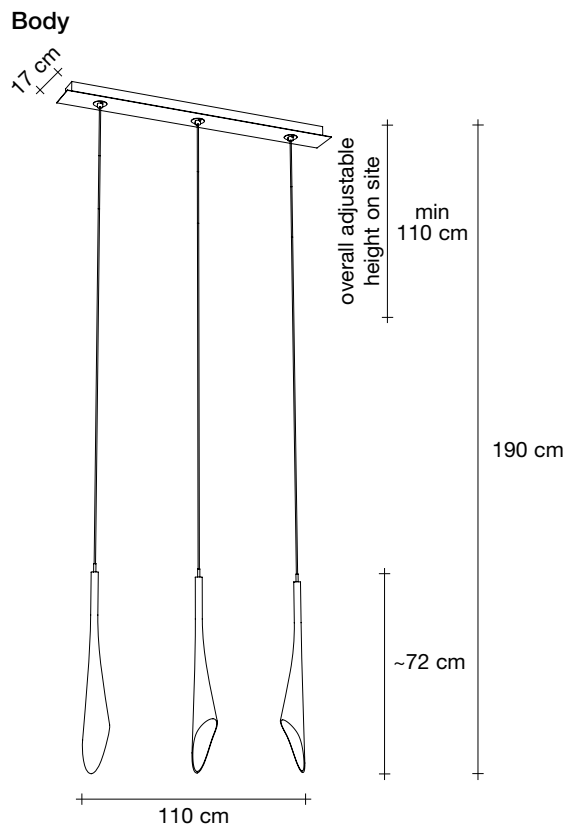

### Light source options

230-240V ~ 50/60Hz

 halogen  
3 x 20W G4 12V

or

 led  
3 x 2W G4 12V

**dimming options**

 not dimmable

 IGBT  
DALI

### Canopy | white

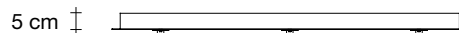
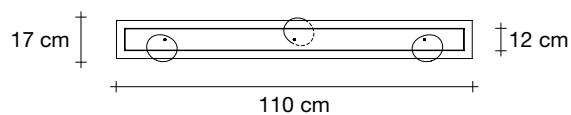

At Terzani, we spend countless days searching the globe for talented new designers, but sometimes they find us. Such is the case with the young designers Luca Martorano and Mattia Albicini (Draw), who approached us with the design for Calle, a fantastic new light we instantly fell in love with. It showcases our skill at crafting crystal, taking the material to an exciting, modern place. Luca and Mattia worked with our craftsmen to create a slender inverted flute of crystal that, like the calla lily it mimics, can be grouped into stunning bouquets of light. Design Draw.

# Calle, perennial *elegance.*

design Draw  
terzani.com

## TERZANI



**Name**  
Calle  
5 round multi light pendant

**Materials**  
clear crystal

CE ENEC CB

**Finishes | Code**

 clear  
OT05SE8A9

**Body**

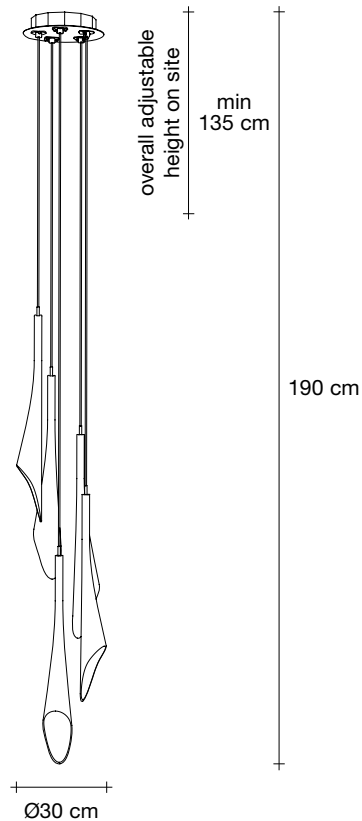

**Light source options**

230-240V ~ 50/60Hz

 halogen  
5 × 20W G4 12V

or

 led  
5 × 2W G4 12V

**dimming options**

 IGBT  
1-10V  
PWM  
DALI

**Canopy | white**

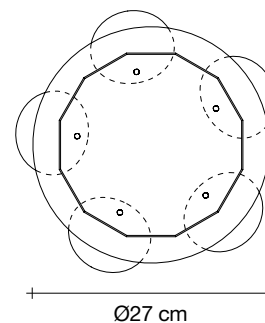

At Terzani, we spend countless days searching the globe for talented new designers, but sometimes they find us. Such is the case with the young designers Luca Martorano and Mattia Albicini (Draw), who approached us with the design for Calle, a fantastic new light we instantly fell in love with. It showcases our skill at crafting crystal, taking the material to an exciting, modern place. Luca and Mattia worked with our craftsmen to create a slender inverted flute of crystal that, like the calla lily it mimics, can be grouped into stunning bouquets of light. Design Draw.

# Calle, perennial *elegance.*

design Draw  
terzani.com

# TERZANI



**Name**  
Calle  
5 linear multi light pendant

**Materials**  
clear crystal

CE ENEC CB

**Finishes | Code**

 clear  
OT05SE8A9R

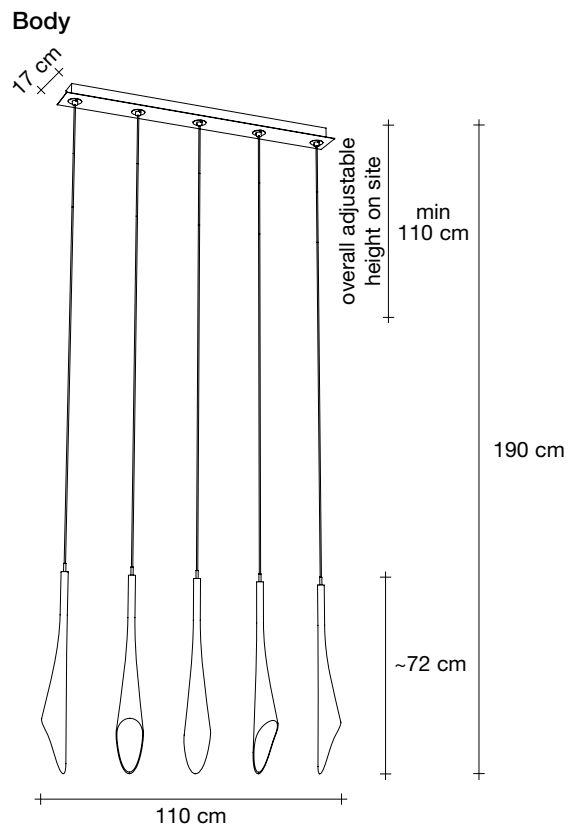

**Light source options**

230-240V ~ 50/60Hz

 halogen  
5 x 20W G4 12V

or

 led  
5 x 2W G4 12V

**dimnable options**

 IGBT  
1-10V  
PWM  
DALI

**Canopy | white**

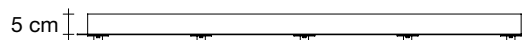
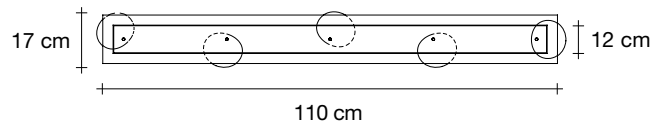

At Terzani, we spend countless days searching the globe for talented new designers, but sometimes they find us. Such is the case with the young designers Luca Martorano and Mattia Albicini (Draw), who approached us with the design for Calle, a fantastic new light we instantly fell in love with. It showcases our skill at crafting crystal, taking the material to an exciting, modern place. Luca and Mattia worked with our craftsmen to create a slender inverted flute of crystal that, like the calla lily it mimics, can be grouped into stunning bouquets of light. Design Draw.