

# Argent, a precious, *cloud.*

design Dodo Arslan  
terzani.com

# TERZANI



**Name**  
Argent  
pendant light

**Materials**  
stainless steel

### Finishes | Code

-  stainless steel  
ON90SE7C8KK
-  gold  
ON90SP7C8KK
-  sunset rose  
ON90SA8C8KK
-  champagne  
ON90SQ1C8KK

### Body

NO DRIVER INCLUDED

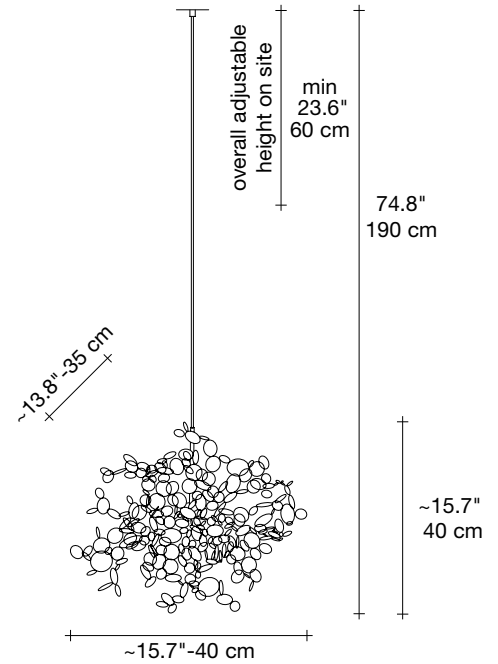

### Light source options

12V ~ 50/60Hz

 XENON-T3  
3 x 20W G4 12V

or

 LED  
3 x 2W G4 12V

dimnable drivers available

 ELV

### Disc | white

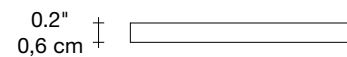
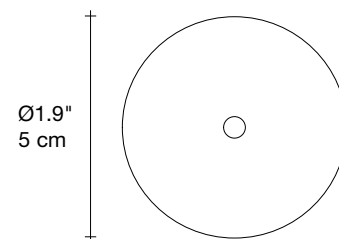

With this light, designer Dodo Arslan creates a shimmering cloud. Argent consists of metal discs that have been meticulously shaped by Terzani craftsmen into clusters. Once lit, the multiple angled surfaces of the discs emanate a soft, shimmering glow. Argent is available in stainless steel, gold, sunset rose, and champagne finishes. Black nickel plated is available on request. Design Dodo Arslan.

# Argent, a precious, *cloud.*

design Dodo Arslan  
terzani.com

# TERZANI







**Name**  
Argent  
pendant light

**Materials**  
stainless steel



**Finishes | Code**

-  stainless steel  
ON90SE7C8
-  gold  
ON90SP7C8
-  sunset rose  
ON90SA8C8
-  champagne  
ON90SQ1C8

**Body**

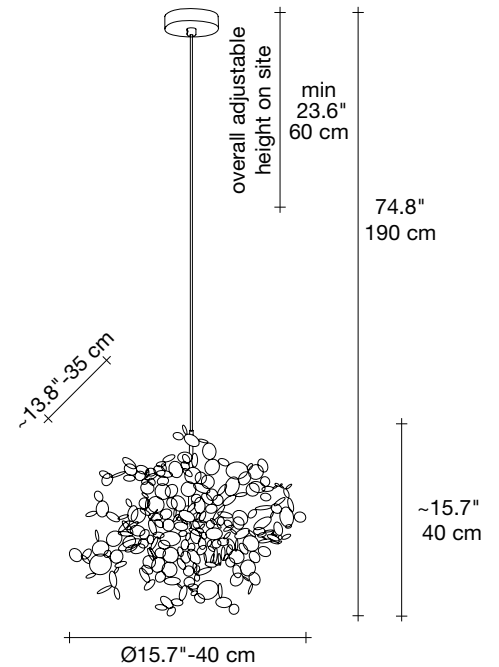

**Light source options**

120V ~ 50/60Hz

 XENON-T3  
3 x 20W G4 12V

or

 LED  
3 x 2W G4 12V

dimmable options

 ELV

**Canopy | white**

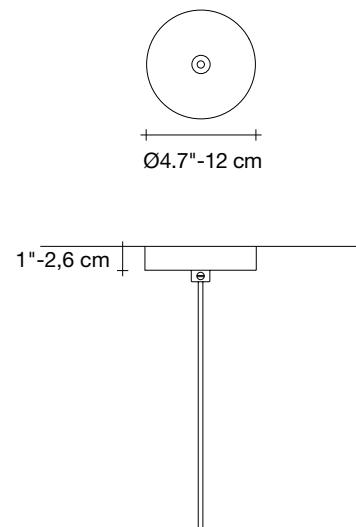

With this light, designer Dodo Arslan creates a shimmering cloud. Argent consists of metal discs that have been meticulously shaped by Terzani craftsmen into clusters. Once lit, the multiple angled surfaces of the discs emanate a soft, shimmering glow. Argent is available in stainless steel, gold, sunset rose, and champagne finishes. Black nickel plated is available on request. Design Dodo Arslan.

# Argent, a precious, *cloud.*

design Dodo Arslan  
terzani.com

# TERZANI



**Name**  
Argent  
4 round multi light pendant

**Materials**  
stainless steel



**Finishes | Code**

-  stainless steel  
ON91SE7C8
-  gold  
ON91SP7C8
-  sunset rose  
ON91SA8C8
-  champagne  
ON91SQ1C8

**Body**

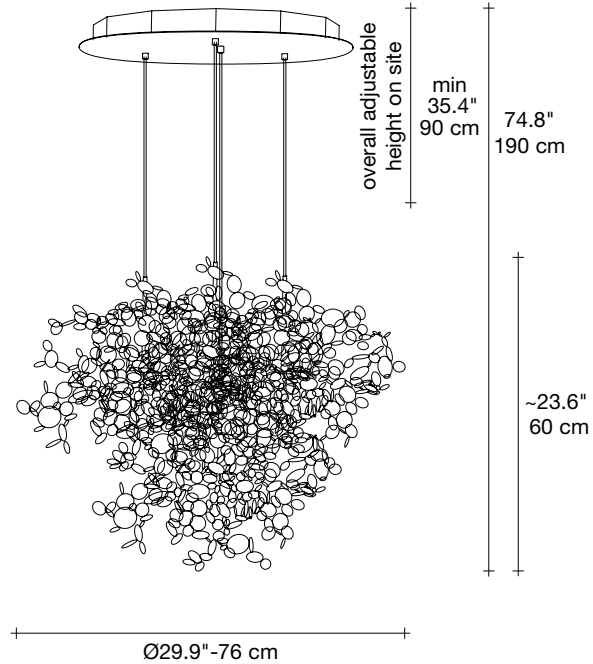

**Light source options**

120V ~ 50/60Hz

 XENON-T3  
12 x 20W G4 12V

or

 LED  
12 x 2W G4 12V



**dimmable options**

 ELV

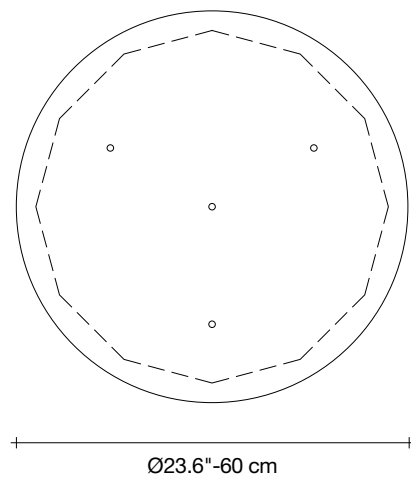
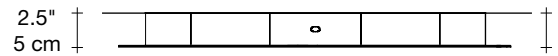
**Canopy | white**



With this light, designer Dodo Arslan creates a shimmering cloud. Argent consists of metal discs that have been meticulously shaped by Terzani craftsmen into clusters. Once lit, the multiple angled surfaces of the discs emanate a soft, shimmering glow. Argent is available in stainless steel, gold, sunset rose, and champagne finishes. Black nickel plated is available on request. Design Dodo Arslan.

-  40.8 lbs  
18,5 kg
-  61.7 lbs  
28 kg
-  33.1" x 33.1" x 28.3"  
84 x 84 x 72 cm

# Argent, a precious, *cloud.*

design Dodo Arslan  
terzani.com

**TERZANI**







**Name**  
Argent  
4 linear multi light pendant

**Materials**  
stainless steel



**Finishes | Code**

-  stainless steel  
ON92SE7C8
-  gold  
ON92SP7C8
-  sunset rose  
ON92SA8C8
-  champagne  
ON92SQ1C8

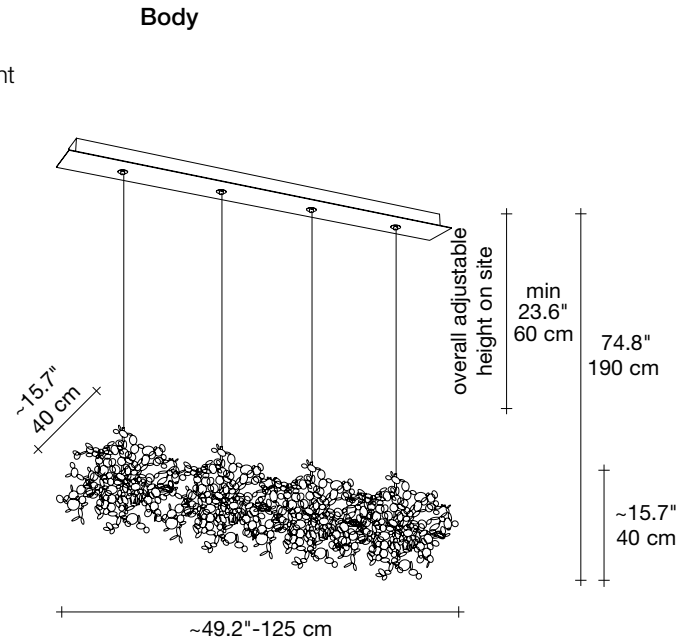

**Light source options**

**120V ~ 50/60Hz**

 XENON-T3  
12 x 20W G4 12V

or

 LED  
12 x 2W G4 12V



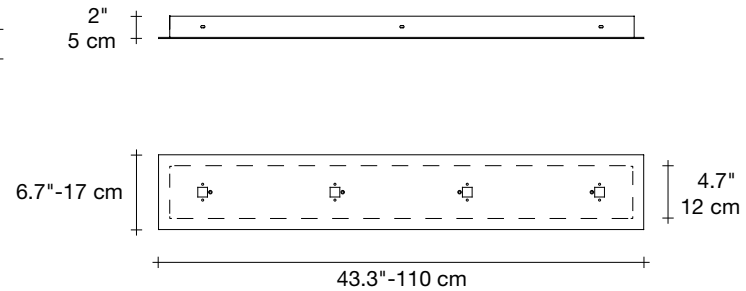

dimmable options

 ELV

**Canopy | white**



With this light, designer Dodo Arslan creates a shimmering cloud. Argent consists of metal discs that have been meticulously shaped by Terzani craftsmen into clusters. Once lit, the multiple angled surfaces of the discs emanate a soft, shimmering glow. Argent is available in stainless steel, gold, sunset rose, and champagne finishes. Black nickel plated is available on request. Design Dodo Arslan.

-  32.6 lbs  
14,8 kg
-  1x 17.6 lbs  
1x 7 lbs  
 1x 8 kg  
1x 3,2 kg
-  1x 46" x 11.4" x 6.3"  
4x 16.1" x 16.1" x 16.1"  
 1x 117 x 29 x 16 cm  
4x 41 x 41 x 41 cm

# Argent, a precious, *cloud*.

design Dodo Arslan  
terzani.com

# TERZANI







**Name**  
Argent  
6 linear multi light pendant

**Materials**  
stainless steel



**Finishes | Code**

-  stainless steel  
ON89SE7C8
-  gold  
ON89SP7C8
-  sunset rose  
ON89SA8C8
-  champagne  
ON89SQ1C8

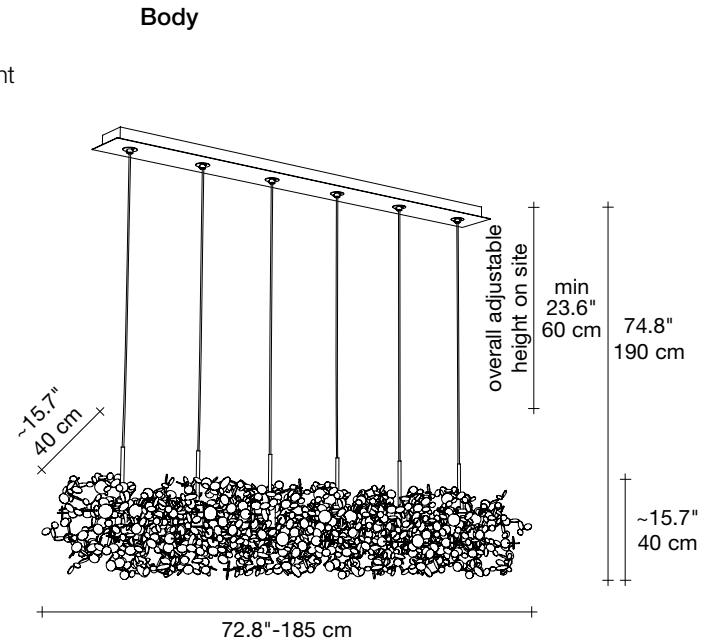

**Light source options**

120V ~ 50/60Hz

 XENON-T3  
18 x 20W G4 12V

or

 LED  
18 x 2W G4 12V







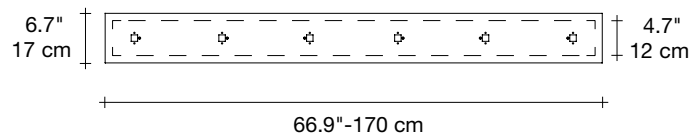
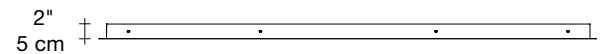

dimmable options

 ELV

**Canopy | white**



With this light, designer Dodo Arslan creates a shimmering cloud. Argent consists of metal discs that have been meticulously shaped by Terzani craftsmen into clusters. Once lit, the multiple angled surfaces of the discs emanate a soft, shimmering glow. Argent is available in stainless steel, gold, sunset rose, and champagne finishes. Black nickel plated is available on request. Design Dodo Arslan.

-  50.7 lbs
-  1x 24.6 lbs
-  1x 69.6" x 11.4" x 6.3"
- 22 kg
-  1x 7 lbs
-  6x 16.1" x 16.1" x 16.1"
-  1x 12 kg
-  1x 175 x 29 x 16 cm
-  1x 3,2 kg
-  6x 41 x 41 x 41 cm

# Argent, a precious, *cloud.*

design Dodo Arslan  
terzani.com

# TERZANI







**Name**  
Argent  
small chandelier

**Materials**  
stainless steel



**Finishes | Code**

-  stainless steel  
ON95SE7C8
-  gold  
ON95SP7C8
-  sunset rose  
ON95SA8C8
-  champagne  
ON95SQ1C8

**Body**

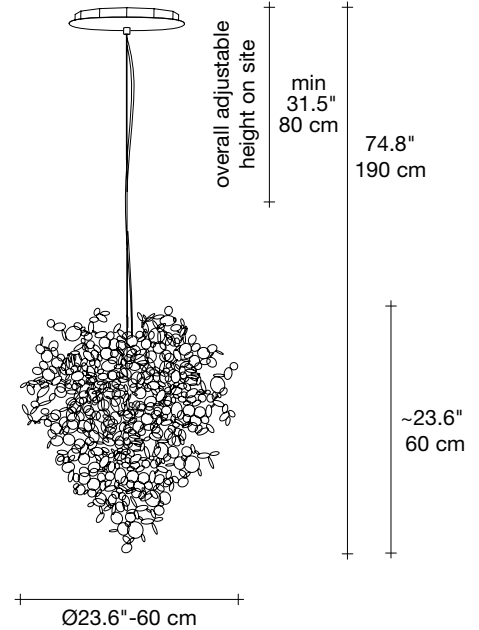

**Light source**  
120V ~ 50/60Hz

-  Built in Replaceable LED Module  
6 x 2.1W 1698 lm 3000K  
or optional 1518 lm 2700K

**dimming options**

-  1-10V  
PUSH

**Canopy | white**

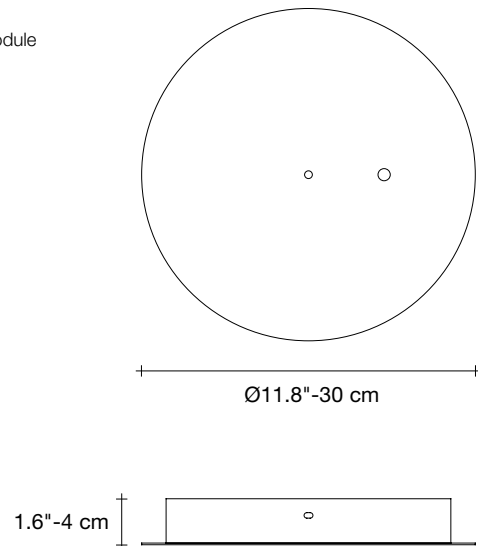

With this light, designer Dodo Arslan creates a shimmering cloud. Argent consists of metal discs that have been meticulously shaped by Terzani craftsmen into clusters. Once lit, the multiple angled surfaces of the discs emanate a soft, shimmering glow. Argent is available in stainless steel, gold, sunset rose, and champagne finishes. Black nickel plated is available on request. Design Dodo Arslan.

# Argent, a precious, *cloud.*

design Dodo Arslan  
terzani.com

# TERZANI







**Name**  
Argent  
medium chandelier

**Materials**  
stainless steel



**Finishes | Code**

-  stainless steel  
ON93SE7C8
-  gold  
ON93SP7C8
-  sunset rose  
ON93SA8C8
-  champagne  
ON93SQ1C8

**Body**

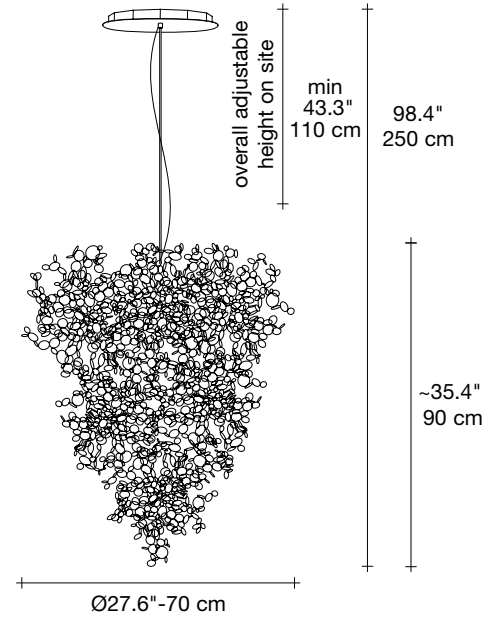

**Light source**  
120V ~ 50/60Hz

-  Built in Replaceable LED Module  
12 x 2.1W 3396 lm 3000K  
or optional 3036 lm 2700K

**dimnable options**

-  0/1-10V  
PUSH  
DALI

**Canopy | white**

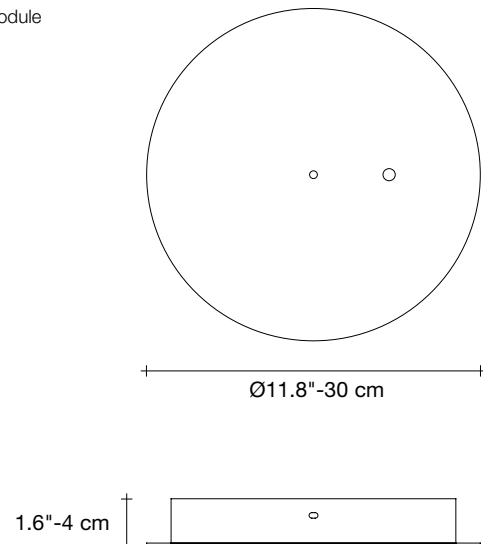

With this light, designer Dodo Arslan creates a shimmering cloud. Argent consists of metal discs that have been meticulously shaped by Terzani craftsmen into clusters. Once lit, the multiple angled surfaces of the discs emanate a soft, shimmering glow. Argent is available in stainless steel, gold, sunset rose, and champagne finishes. Black nickel plated is available on request. Design Dodo Arslan.

# Argent, a precious, *cloud.*

design Dodo Arslan  
terzani.com





# TERZANI



**Name**  
Argent  
large chandelier

**Materials**  
stainless steel

### Finishes | Code

-  stainless steel  
ON94SE7C8
-  gold  
ON94SP7C8
-  sunset rose  
ON94SA8C8
-  champagne  
ON94SQ1C8

### Body

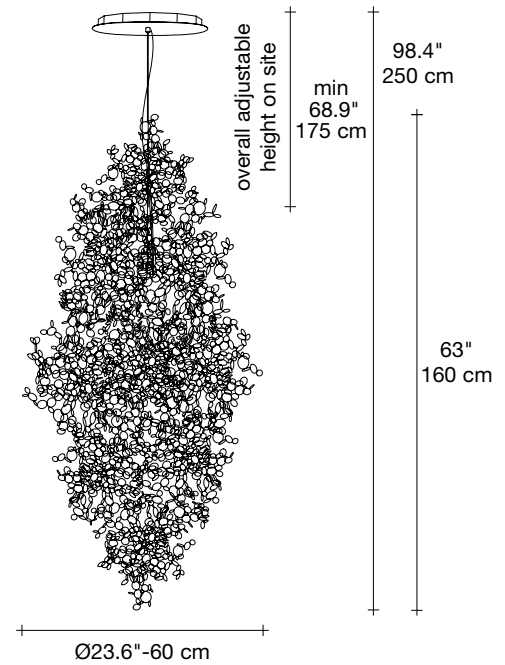

**Light source**  
120V ~ 50/60Hz

-  Built in Replaceable LED Module  
18 x 2.1W 5094 lm 3000K  
or optional 4554 lm 2700K

### dimming options

-  0/1-10V  
PUSH  
DALI

### Canopy | white

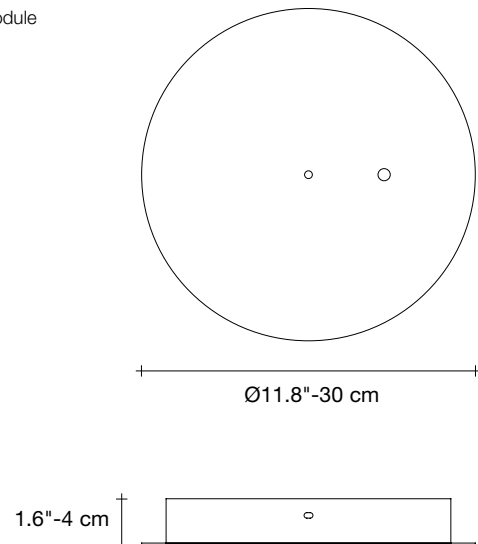

With this light, designer Dodo Arslan creates a shimmering cloud. Argent consists of metal discs that have been meticulously shaped by Terzani craftsmen into clusters. Once lit, the multiple angled surfaces of the discs emanate a soft, shimmering glow. Argent is available in stainless steel, gold, sunset rose, and champagne finishes. Black nickel plated is available on request. Design Dodo Arslan.

# Argent, a precious, *cloud.*

design Dodo Arslan  
terzani.com

# TERZANI





**Name**  
Argent  
wall sconce

**Materials**  
stainless steel



### Finishes | Code

-  stainless steel  
0N97AE7C8
-  gold  
0N97AP7C8
-  sunset rose  
0N97AA8C8
-  champagne  
0N97AQ1C8

### Body

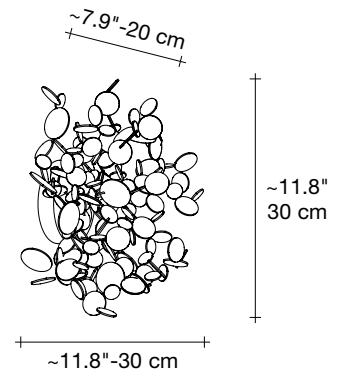

### Light source options

120V ~ 50/60Hz

 XENON-T3  
3 × 20W G4 12V

or

 LED  
3 × 2W G4 12V

dimnable options

 ELV

### Canopy

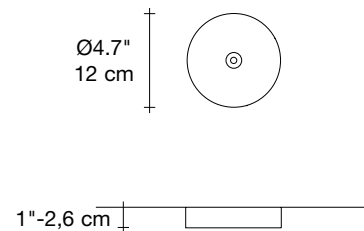

With this light, designer Dodo Arslan creates a shimmering cloud. Argent consists of metal discs that have been meticulously shaped by Terzani craftsmen into clusters. Once lit, the multiple angled surfaces of the discs emanate a soft, shimmering glow. Argent is available in stainless steel, gold, sunset rose, and champagne finishes. Black nickel plated is available on request. Design Dodo Arslan.

# Argent, a precious, *cloud.*

design Dodo Arslan  
terzani.com

# TERZANI







**Name**  
Argent  
ceiling light

**Materials**  
stainless steel



### Finishes | Code

-  stainless steel  
ON99LE7C8
-  gold  
ON99LP7C8
-  sunset rose  
ON99LA8C8
-  champagne  
ON99LQ1C8

### Body

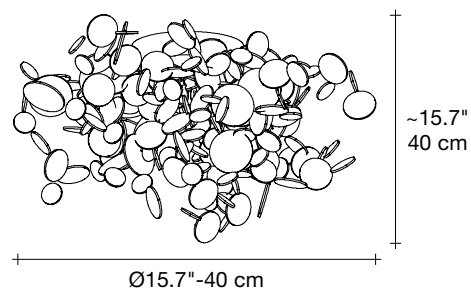

### Light source options

**120V ~ 50/60Hz**

 XENON-T3  
3 × 20W G4 12V

or

 LED  
3 × 2W G4 12V

**dimnable options**

 ELV

### Canopy

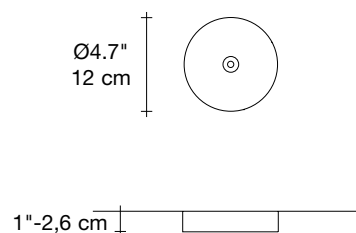

With this light, designer Dodo Arslan creates a shimmering cloud. Argent consists of metal discs that have been meticulously shaped by Terzani craftsmen into clusters. Once lit, the multiple angled surfaces of the discs emanate a soft, shimmering glow. Argent is available in stainless steel, gold, sunset rose, and champagne finishes. Black nickel plated is available on request. Design Dodo Arslan.

# Argent, a precious, *cloud.*

design Dodo Arslan  
terzani.com

# TERZANI







**Name**  
Argent  
pendant light

**Materials**  
stainless steel



### Finishes | Code

-  stainless steel  
ON90SE7C8
-  gold  
ON90SP7C8
-  sunset rose  
ON90SA8C8
-  champagne  
ON90SQ1C8

### Body

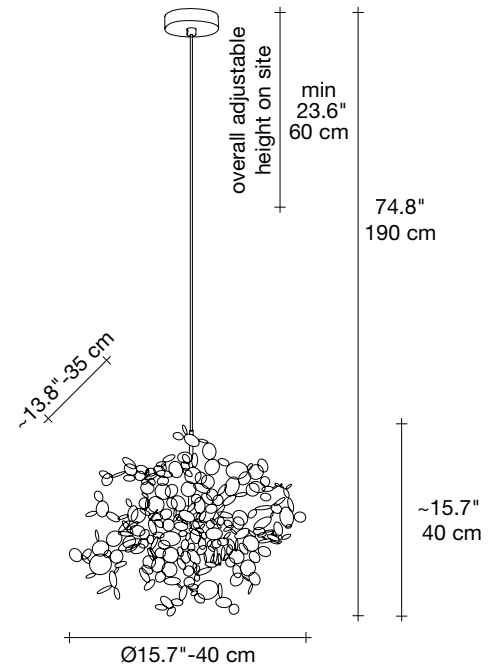

### Light source options

120V ~ 50/60Hz

 XENON-T3  
3 × 20W G4 12V

or

 LED  
3 × 2W G4 12V

**dimnable options**

 ELV

### Canopy | white

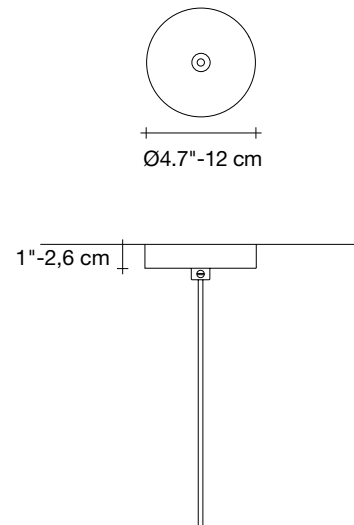

With this light, designer Dodo Arslan creates a shimmering cloud. Argent consists of metal discs that have been meticulously shaped by Terzani craftsmen into clusters. Once lit, the multiple angled surfaces of the discs emanate a soft, shimmering glow. Argent is available in stainless steel, gold, sunset rose, and champagne finishes. Black nickel plated is available on request. Design Dodo Arslan.

# Argent, a precious, *cloud.*

design Dodo Arslan  
terzani.com

# TERZANI



**Name**  
Argent  
4 round multi light pendant

**Materials**  
stainless steel



**Finishes | Code**

-  stainless steel  
ON91SE7C8
-  gold  
ON91SP7C8
-  sunset rose  
ON91SA8C8
-  champagne  
ON91SQ1C8

**Body**

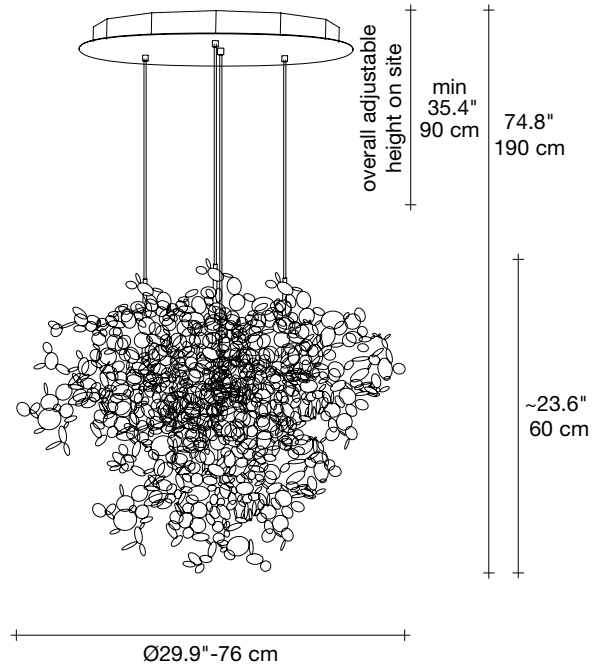

**Light source options**

120V ~ 50/60Hz

 XENON-T3  
12 x 20W G4 12V

or

 LED  
12 x 2W G4 12V



**dimnable options**

 ELV

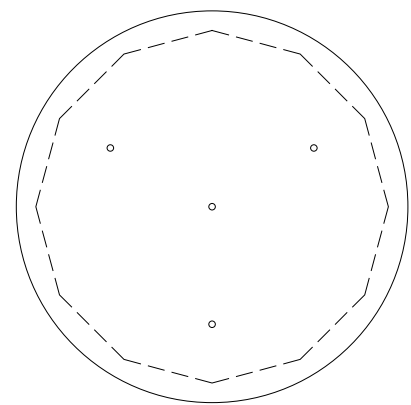
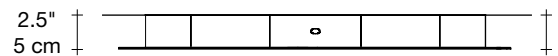
**Canopy | white**



With this light, designer Dodo Arslan creates a shimmering cloud. Argent consists of metal discs that have been meticulously shaped by Terzani craftsmen into clusters. Once lit, the multiple angled surfaces of the discs emanate a soft, shimmering glow. Argent is available in stainless steel, gold, sunset rose, and champagne finishes. Black nickel plated is available on request. Design Dodo Arslan.

-  40.8 lbs  
18,5 kg
-  61.7 lbs  
28 kg
-  33.1" x 33.1" x 28.3"  
84 x 84 x 72 cm

# Argent, a precious, *cloud*.

design Dodo Arslan  
terzani.com

# TERZANI







**Name**  
Argent  
4 linear multi light pendant

**Materials**  
stainless steel



**Finishes | Code**

-  stainless steel  
ON92SE7C8
-  gold  
ON92SP7C8
-  sunset rose  
ON92SA8C8
-  champagne  
ON92SQ1C8

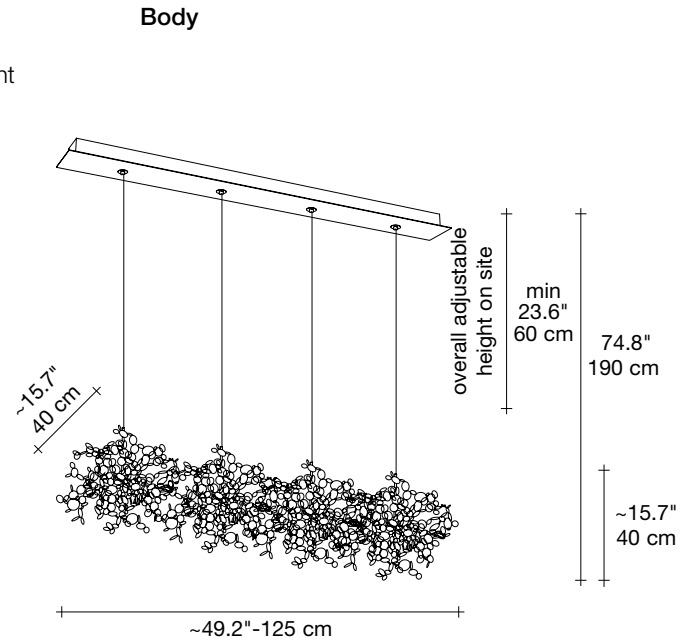

**Light source options**

**120V ~ 50/60Hz**

 XENON-T3  
12 x 20W G4 12V

or

 LED  
12 x 2W G4 12V



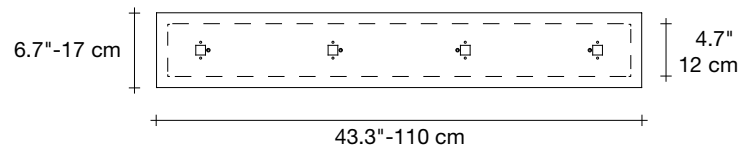
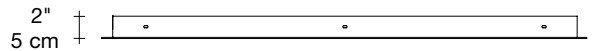

dimnable options

 ELV

**Canopy | white**



With this light, designer Dodo Arslan creates a shimmering cloud. Argent consists of metal discs that have been meticulously shaped by Terzani craftsmen into clusters. Once lit, the multiple angled surfaces of the discs emanate a soft, shimmering glow. Argent is available in stainless steel, gold, sunset rose, and champagne finishes. Black nickel plated is available on request. Design Dodo Arslan.

-  32.6 lbs  
14,8 kg
-  1x 17.6 lbs  
1x 7 lbs  
 1x 8 kg  
1x 3,2 kg
-  1x 46" x 11.4" x 6.3"  
4x 16.1" x 16.1" x 16.1"  
 1x 117 x 29 x 16 cm  
4x 41 x 41 x 41 cm

# Argent, a precious, *cloud*.

design Dodo Arslan  
terzani.com

# TERZANI







**Name**  
Argent  
6 linear multi light pendant

**Materials**  
stainless steel



**Finishes | Code**

-  stainless steel  
ON89SE7C8
-  gold  
ON89SP7C8
-  sunset rose  
ON89SA8C8
-  champagne  
ON89SQ1C8

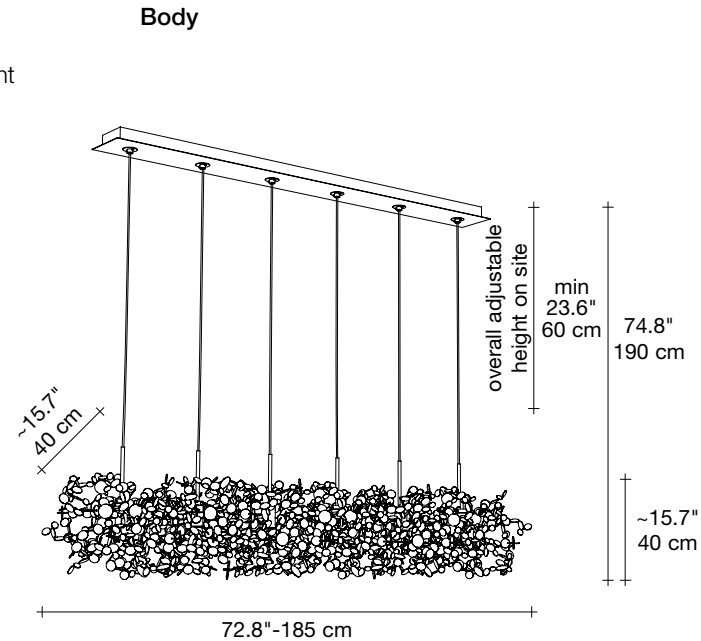

**Light source options**

120V ~ 50/60Hz

 XENON-T3  
18 x 20W G4 12V

or

 LED  
18 x 2W G4 12V







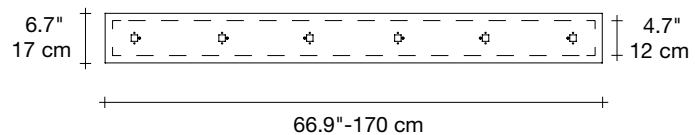
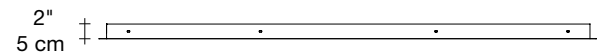



dimnable options

 ELV

**Canopy | white**



With this light, designer Dodo Arslan creates a shimmering cloud. Argent consists of metal discs that have been meticulously shaped by Terzani craftsmen into clusters. Once lit, the multiple angled surfaces of the discs emanate a soft, shimmering glow. Argent is available in stainless steel, gold, sunset rose, and champagne finishes. Black nickel plated is available on request. Design Dodo Arslan.

-  50.7 lbs  
 22 kg
-  1x 24.6 lbs  
 1x 7 lbs  
 1x 12 kg  
 1x 3,2 kg
-  1x 69.6" x 11.4" x 6.3"  
 6x 16.1" x 16.1" x 16.1"  
 1x 175 x 29 x 16 cm  
 6x 41 x 41 x 41 cm

# Argent, a precious, *cloud.*

design Dodo Arslan  
terzani.com

# TERZANI







**Name**  
Argent  
small chandelier

**Materials**  
stainless steel



**Finishes | Code**

-  stainless steel  
ON95SE7C8
-  gold  
ON95SP7C8
-  sunset rose  
ON95SA8C8
-  champagne  
ON95SQ1C8

**Body**

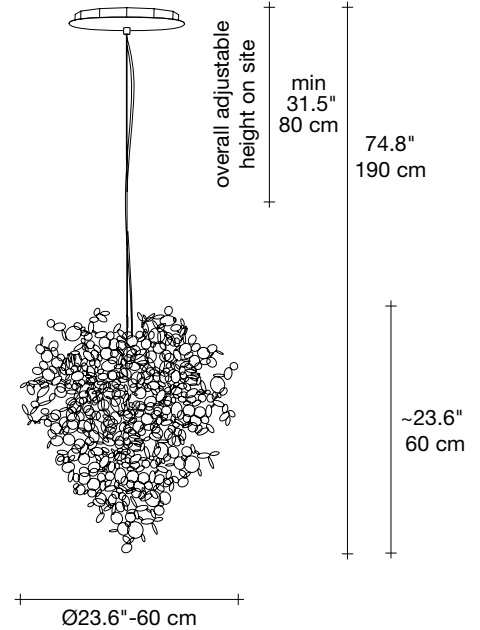

**Light source**  
120V ~ 50/60Hz

 Built in Replaceable LED Module  
6 x 2.1W 1698 lm 3000K  
or optional 1518 lm 2700K

**dimming options**

 1-10V  
PUSH

**Canopy | white**

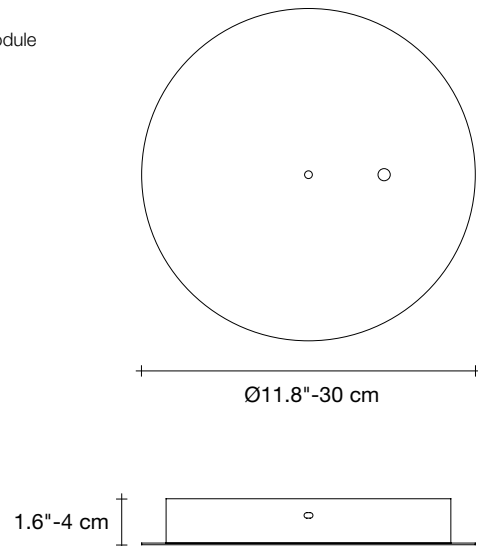

With this light, designer Dodo Arslan creates a shimmering cloud. Argent consists of metal discs that have been meticulously shaped by Terzani craftsmen into clusters. Once lit, the multiple angled surfaces of the discs emanate a soft, shimmering glow. Argent is available in stainless steel, gold, sunset rose, and champagne finishes. Black nickel plated is available on request. Design Dodo Arslan.

# Argent, a precious, *cloud.*

design Dodo Arslan  
terzani.com

# TERZANI







**Name**  
Argent  
medium chandelier

**Materials**  
stainless steel



**Finishes | Code**

-  stainless steel  
ON93SE7C8
-  gold  
ON93SP7C8
-  sunset rose  
ON93SA8C8
-  champagne  
ON93SQ1C8

**Body**

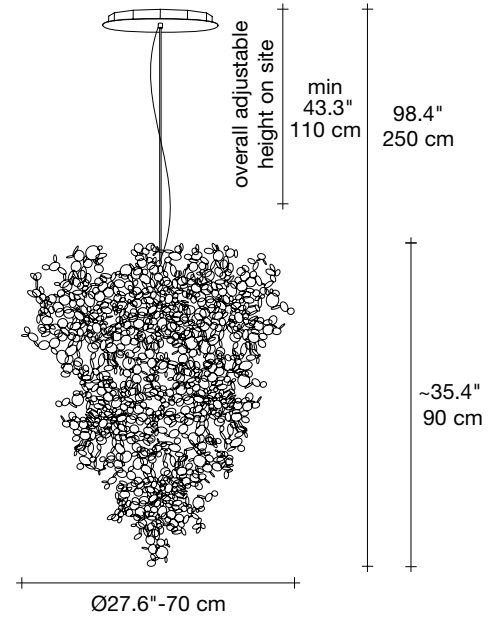

**Light source**  
120V ~ 50/60Hz

-  Built in Replaceable LED Module  
12 x 2.1W 3396 lm 3000K  
or optional 3036 lm 2700K

**dimnable options**

-  0/1-10V  
PUSH  
DALI

**Canopy | white**

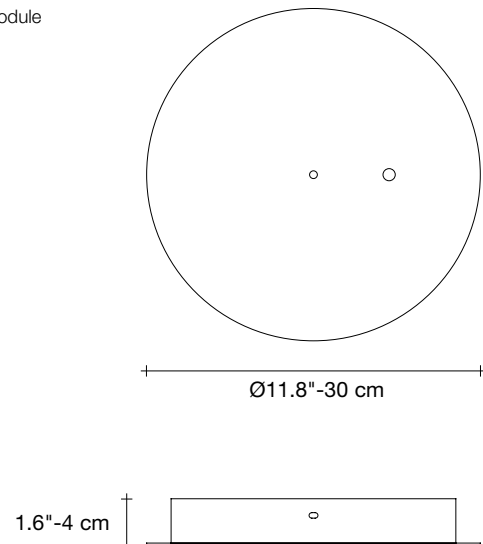

With this light, designer Dodo Arslan creates a shimmering cloud. Argent consists of metal discs that have been meticulously shaped by Terzani craftsmen into clusters. Once lit, the multiple angled surfaces of the discs emanate a soft, shimmering glow. Argent is available in stainless steel, gold, sunset rose, and champagne finishes. Black nickel plated is available on request. Design Dodo Arslan.

# Argent, a precious, *cloud.*

design Dodo Arslan  
terzani.com





# TERZANI



**Name**  
Argent  
large chandelier

**Materials**  
stainless steel

### Finishes | Code

-  stainless steel  
ON94SE7C8
-  gold  
ON94SP7C8
-  sunset rose  
ON94SA8C8
-  champagne  
ON94SQ1C8

### Body

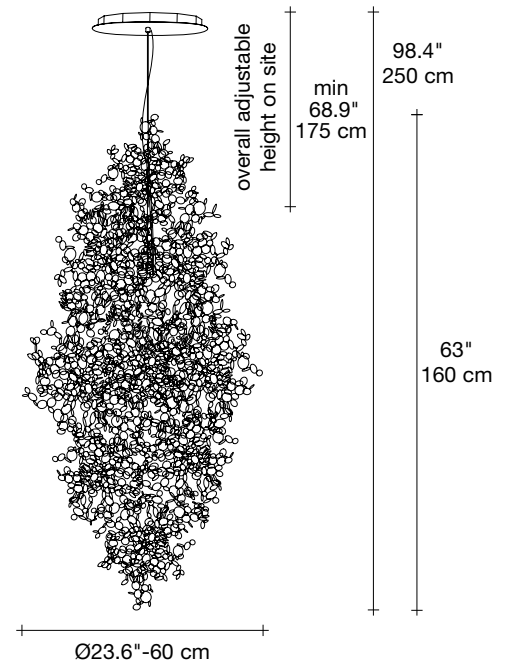

### Light source

120V ~ 50/60Hz

-  Built in Replaceable LED Module  
18 x 2.1W 5094 lm 3000K  
or optional 4554 lm 2700K

#### dimnable options

-  0/1-10V  
PUSH  
DALI

### Canopy | white

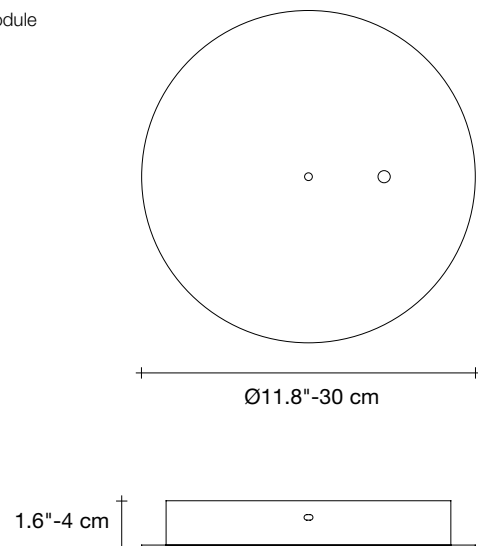

With this light, designer Dodo Arslan creates a shimmering cloud. Argent consists of metal discs that have been meticulously shaped by Terzani craftsmen into clusters. Once lit, the multiple angled surfaces of the discs emanate a soft, shimmering glow. Argent is available in stainless steel, gold, sunset rose, and champagne finishes. Black nickel plated is available on request. Design Dodo Arslan.

# Argent, a precious, *cloud.*

design Dodo Arslan  
terzani.com

# TERZANI



**Name**  
Argent  
wall sconce

**Materials**  
stainless steel



### Finishes | Code

-  stainless steel  
0N97AE7C8
-  gold  
0N97AP7C8
-  sunset rose  
0N97AA8C8
-  champagne  
0N97AQ1C8

### Body

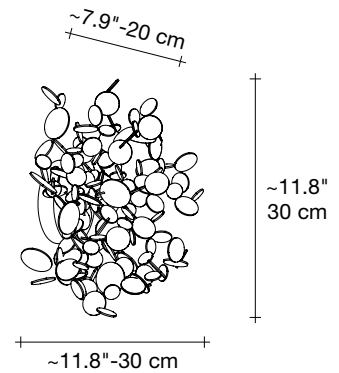

### Light source options

120V ~ 50/60Hz

 XENON-T3  
3 × 20W G4 12V

or

 LED  
3 × 2W G4 12V

dimnable options

 ELV

### Canopy

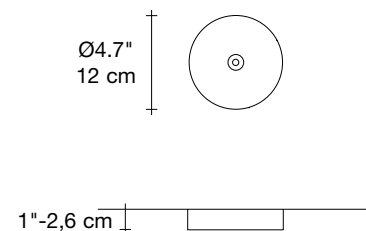

With this light, designer Dodo Arslan creates a shimmering cloud. Argent consists of metal discs that have been meticulously shaped by Terzani craftsmen into clusters. Once lit, the multiple angled surfaces of the discs emanate a soft, shimmering glow. Argent is available in stainless steel, gold, sunset rose, and champagne finishes. Black nickel plated is available on request. Design Dodo Arslan.

# Argent, a precious, *cloud.*

design Dodo Arslan  
terzani.com

# TERZANI







**Name**  
Argent  
ceiling light

**Materials**  
stainless steel



### Finishes | Code

-  stainless steel  
ON99LE7C8
-  gold  
ON99LP7C8
-  sunset rose  
ON99LA8C8
-  champagne  
ON99LQ1C8

### Body

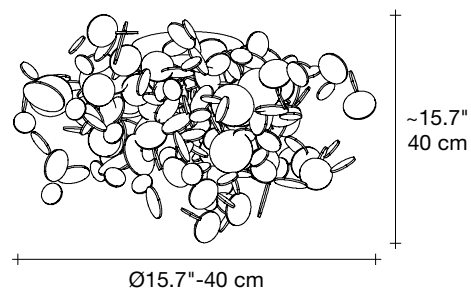

### Light source options

120V ~ 50/60Hz

 XENON-T3  
3 × 20W G4 12V

or

 LED  
3 × 2W G4 12V

dimnable options

 ELV

### Canopy

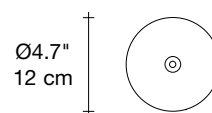

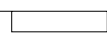
1"-2,6 cm 

With this light, designer Dodo Arslan creates a shimmering cloud. Argent consists of metal discs that have been meticulously shaped by Terzani craftsmen into clusters. Once lit, the multiple angled surfaces of the discs emanate a soft, shimmering glow. Argent is available in stainless steel, gold, sunset rose, and champagne finishes. Black nickel plated is available on request. Design Dodo Arslan.

# Argent, a precious, *cloud.*

design Dodo Arslan  
terzani.com

# TERZANI







**Name**  
Argent  
pendant light

**Materials**  
stainless steel



### Finishes | Code

-  stainless steel  
ON90SE7C8
-  gold  
ON90SP7C8
-  sunset rose  
ON90SA8C8
-  champagne  
ON90SQ1C8

### Body

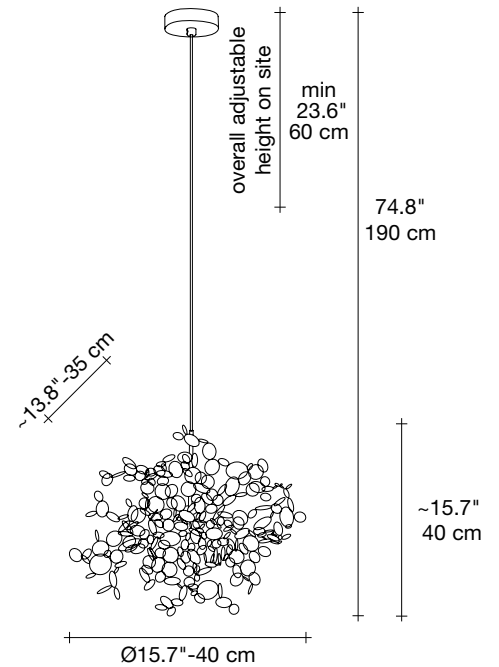

### Light source options

120V ~ 50/60Hz

 XENON-T3  
3 x 20W G4 12V

or

 LED  
3 x 2W G4 12V

**dimnable options**

 ELV

### Canopy | white

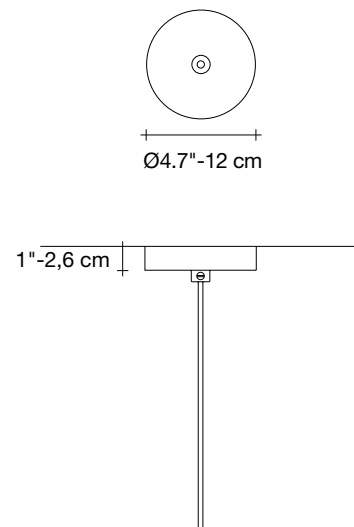

With this light, designer Dodo Arslan creates a shimmering cloud. Argent consists of metal discs that have been meticulously shaped by Terzani craftsmen into clusters. Once lit, the multiple angled surfaces of the discs emanate a soft, shimmering glow. Argent is available in stainless steel, gold, sunset rose, and champagne finishes. Black nickel plated is available on request. Design Dodo Arslan.

# Argent, a precious, *cloud.*

design Dodo Arslan  
terzani.com

# TERZANI



**Name**  
Argent  
4 round multi light pendant

**Materials**  
stainless steel



**Finishes | Code**

-  stainless steel  
ON91SE7C8
-  gold  
ON91SP7C8
-  sunset rose  
ON91SA8C8
-  champagne  
ON91SQ1C8

**Body**

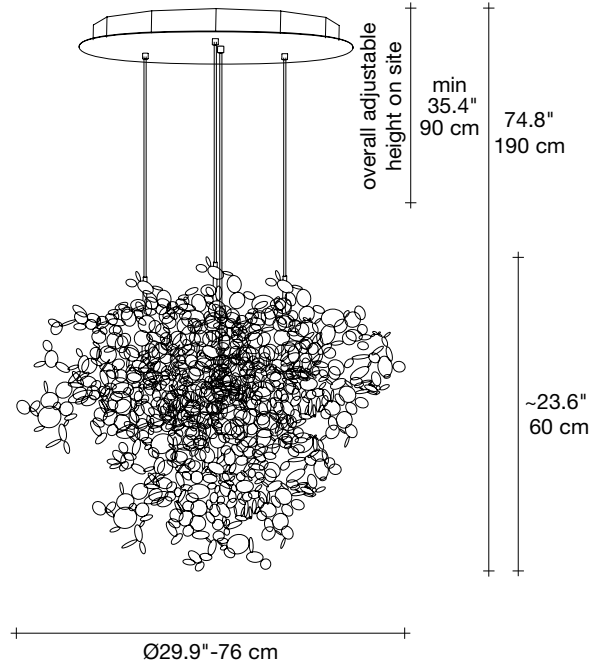

**Light source options**

120V ~ 50/60Hz

 XENON-T3  
12 x 20W G4 12V

or

 LED  
12 x 2W G4 12V

**dimmable options**

 ELV

**Canopy | white**

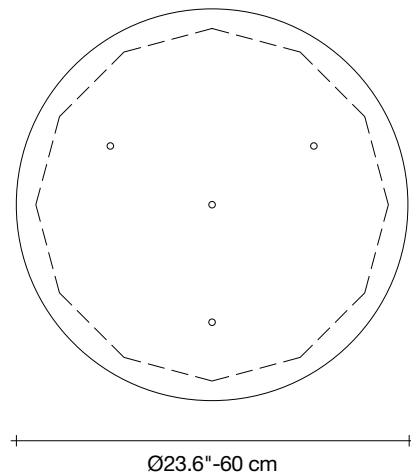
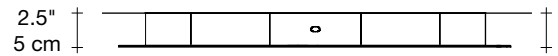

With this light, designer Dodo Arslan creates a shimmering cloud. Argent consists of metal discs that have been meticulously shaped by Terzani craftsmen into clusters. Once lit, the multiple angled surfaces of the discs emanate a soft, shimmering glow. Argent is available in stainless steel, gold, sunset rose, and champagne finishes. Black nickel plated is available on request. Design Dodo Arslan.

 40.8 lbs  
18,5 kg

 61.7 lbs  
28 kg

 33.1" x 33.1" x 28.3"  
84 x 84 x 72 cm

# Argent, a precious, *cloud*.

design Dodo Arslan  
terzani.com

# TERZANI







**Name**  
Argent  
4 linear multi light pendant

**Materials**  
stainless steel



**Finishes | Code**

-  stainless steel  
ON92SE7C8
-  gold  
ON92SP7C8
-  sunset rose  
ON92SA8C8
-  champagne  
ON92SQ1C8

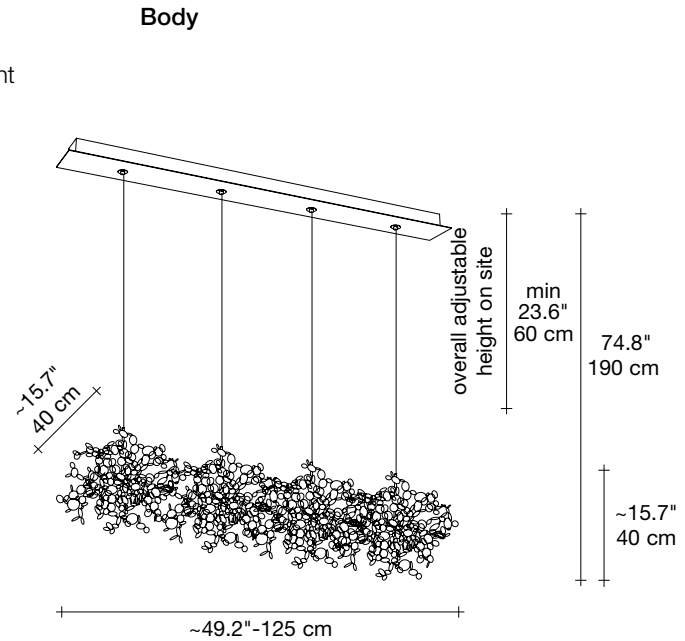

**Light source options**

**120V ~ 50/60Hz**

 XENON-T3  
12 x 20W G4 12V

or

 LED  
12 x 2W G4 12V



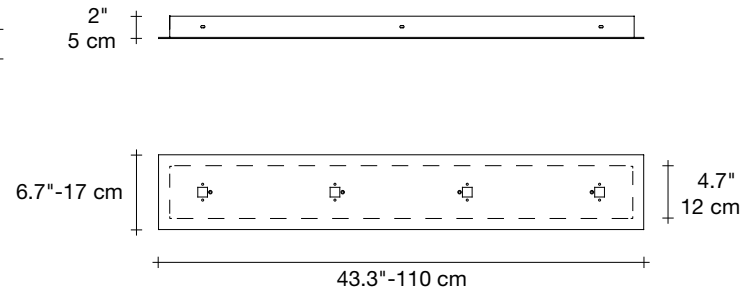

dimnable options

 ELV

**Canopy | white**



With this light, designer Dodo Arslan creates a shimmering cloud. Argent consists of metal discs that have been meticulously shaped by Terzani craftsmen into clusters. Once lit, the multiple angled surfaces of the discs emanate a soft, shimmering glow. Argent is available in stainless steel, gold, sunset rose, and champagne finishes. Black nickel plated is available on request. Design Dodo Arslan.

-  32.6 lbs  
14,8 kg
-  1x 17.6 lbs  
1x 7 lbs  
 1x 8 kg  
1x 3,2 kg
-  1x 46" x 11.4" x 6.3"  
4x 16.1" x 16.1" x 16.1"  
1x 117 x 29 x 16 cm  
4x 41 x 41 x 41 cm

# Argent, a precious, *cloud*.

design Dodo Arslan  
terzani.com

# TERZANI







**Name**  
Argent  
6 linear multi light pendant

**Materials**  
stainless steel



**Finishes | Code**

-  stainless steel  
ON89SE7C8
-  gold  
ON89SP7C8
-  sunset rose  
ON89SA8C8
-  champagne  
ON89SQ1C8

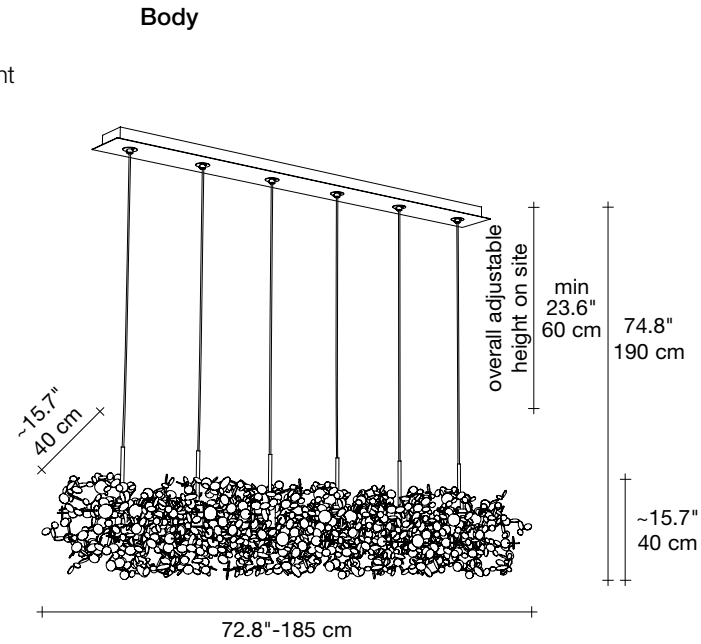

**Light source options**

**120V ~ 50/60Hz**

 XENON-T3  
18 x 20W G4 12V

or

 LED  
18 x 2W G4 12V







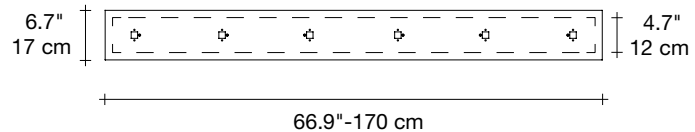
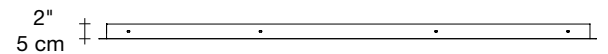



dimmable options

 ELV

**Canopy | white**



With this light, designer Dodo Arslan creates a shimmering cloud. Argent consists of metal discs that have been meticulously shaped by Terzani craftsmen into clusters. Once lit, the multiple angled surfaces of the discs emanate a soft, shimmering glow. Argent is available in stainless steel, gold, sunset rose, and champagne finishes. Black nickel plated is available on request. Design Dodo Arslan.

-  50.7 lbs  
 22 kg
-  1x 24.6 lbs  
 1x 7 lbs  
 1x 12 kg  
 1x 3,2 kg
-  1x 69.6" x 11.4" x 6.3"  
 6x 16.1" x 16.1" x 16.1"  
 1x 175 x 29 x 16 cm  
 6x 41 x 41 x 41 cm

# Argent, a precious, *cloud.*

design Dodo Arslan  
terzani.com

# TERZANI







**Name**  
Argent  
small chandelier

**Materials**  
stainless steel



**Finishes | Code**

-  stainless steel  
ON95SE7C8
-  gold  
ON95SP7C8
-  sunset rose  
ON95SA8C8
-  champagne  
ON95SQ1C8

**Body**

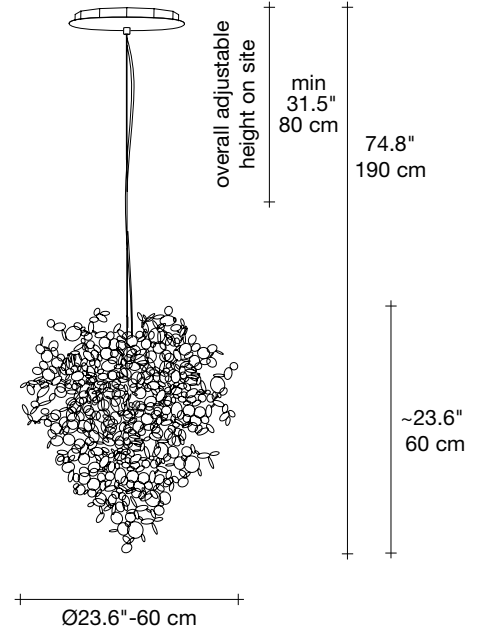

**Light source**  
120V ~ 50/60Hz

-  Built in Replaceable LED Module  
6 x 2.1W 1698 lm 3000K  
or optional 1518 lm 2700K

**dimming options**

-  1-10V  
PUSH

**Canopy | white**

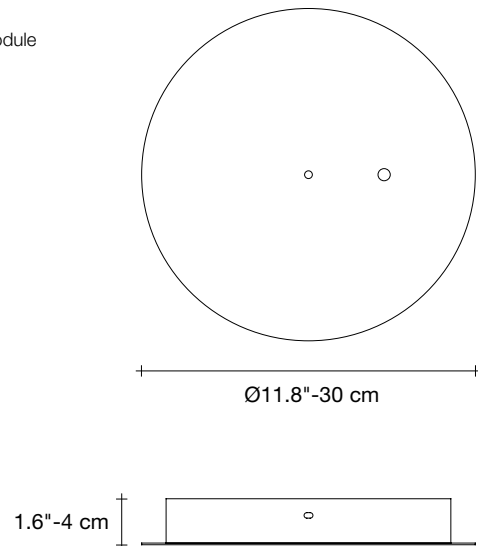

With this light, designer Dodo Arslan creates a shimmering cloud. Argent consists of metal discs that have been meticulously shaped by Terzani craftsmen into clusters. Once lit, the multiple angled surfaces of the discs emanate a soft, shimmering glow. Argent is available in stainless steel, gold, sunset rose, and champagne finishes. Black nickel plated is available on request. Design Dodo Arslan.

# Argent, a precious, *cloud.*

design Dodo Arslan  
terzani.com

# TERZANI







**Name**  
Argent  
medium chandelier

**Materials**  
stainless steel



**Finishes | Code**

-  stainless steel  
ON93SE7C8
-  gold  
ON93SP7C8
-  sunset rose  
ON93SA8C8
-  champagne  
ON93SQ1C8

**Body**

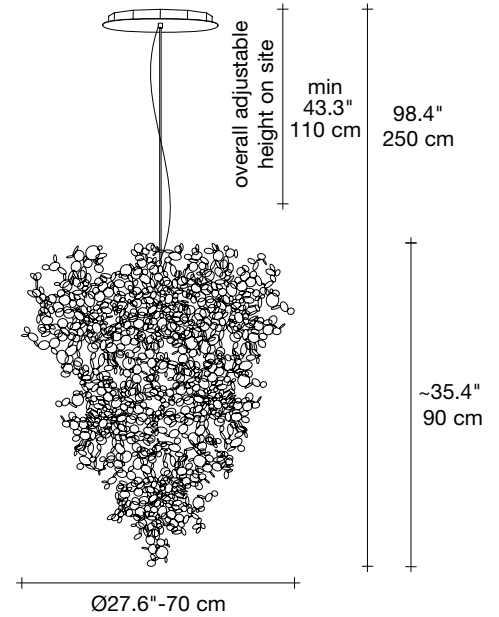

**Light source**  
120V ~ 50/60Hz

-  Built in Replaceable LED Module  
12 x 2.1W 3396 lm 3000K  
or optional 3036 lm 2700K

**dimnable options**

-  0/1-10V  
PUSH  
DALI

**Canopy | white**

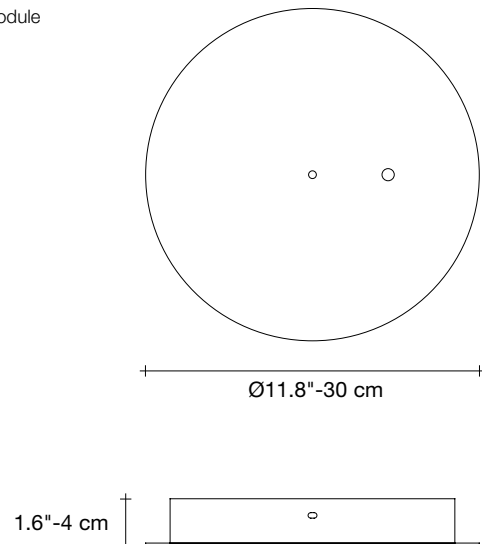

With this light, designer Dodo Arslan creates a shimmering cloud. Argent consists of metal discs that have been meticulously shaped by Terzani craftsmen into clusters. Once lit, the multiple angled surfaces of the discs emanate a soft, shimmering glow. Argent is available in stainless steel, gold, sunset rose, and champagne finishes. Black nickel plated is available on request. Design Dodo Arslan.

# Argent, a precious, *cloud.*

design Dodo Arslan  
terzani.com





# TERZANI



**Name**  
Argent  
large chandelier

**Materials**  
stainless steel

### Finishes | Code

-  stainless steel  
ON94SE7C8
-  gold  
ON94SP7C8
-  sunset rose  
ON94SA8C8
-  champagne  
ON94SQ1C8

### Body

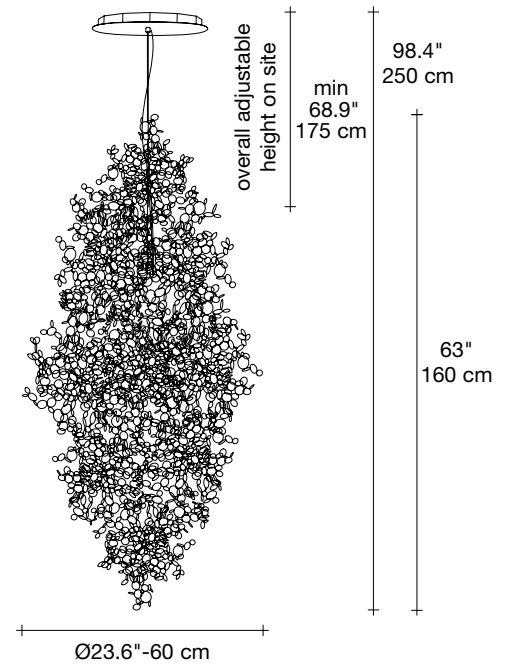

**Light source**  
120V ~ 50/60Hz

-  Built in Replaceable LED Module  
18 x 2.1W 5094 lm 3000K  
or optional 4554 lm 2700K

### dimming options

-  0/1-10V  
PUSH  
DALI

### Canopy | white

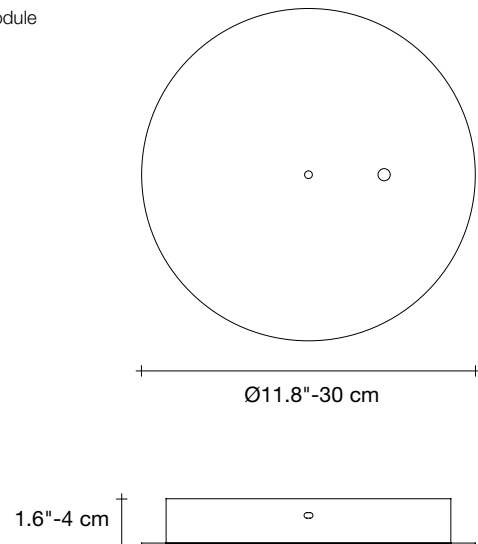

With this light, designer Dodo Arslan creates a shimmering cloud. Argent consists of metal discs that have been meticulously shaped by Terzani craftsmen into clusters. Once lit, the multiple angled surfaces of the discs emanate a soft, shimmering glow. Argent is available in stainless steel, gold, sunset rose, and champagne finishes. Black nickel plated is available on request. Design Dodo Arslan.

# Argent, a precious, *cloud.*

design Dodo Arslan  
terzani.com

# TERZANI





**Name**  
Argent  
wall sconce

**Materials**  
stainless steel



### Finishes | Code

-  stainless steel  
0N97AE7C8
-  gold  
0N97AP7C8
-  sunset rose  
0N97AA8C8
-  champagne  
0N97AQ1C8

### Body

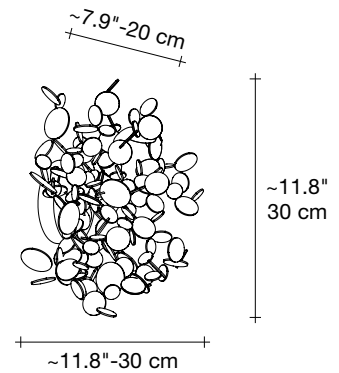

### Light source options

120V ~ 50/60Hz

 XENON-T3  
3 × 20W G4 12V

or

 LED  
3 × 2W G4 12V

dimnable options

 ELV

### Canopy

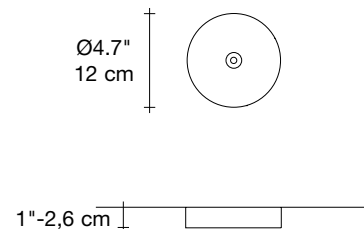

With this light, designer Dodo Arslan creates a shimmering cloud. Argent consists of metal discs that have been meticulously shaped by Terzani craftsmen into clusters. Once lit, the multiple angled surfaces of the discs emanate a soft, shimmering glow. Argent is available in stainless steel, gold, sunset rose, and champagne finishes. Black nickel plated is available on request. Design Dodo Arslan.

# Argent, a precious, *cloud.*

design Dodo Arslan  
terzani.com

# TERZANI







**Name**  
Argent  
ceiling light

**Materials**  
stainless steel



### Finishes | Code

-  stainless steel  
ON99LE7C8
-  gold  
ON99LP7C8
-  sunset rose  
ON99LA8C8
-  champagne  
ON99LQ1C8

### Body

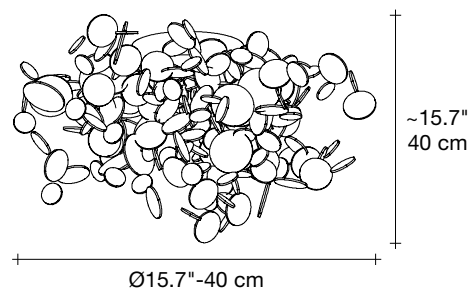

### Light source options

**120V ~ 50/60Hz**

 XENON-T3  
3 × 20W G4 12V

or

 LED  
3 × 2W G4 12V

**dimnable options**

 ELV

### Canopy

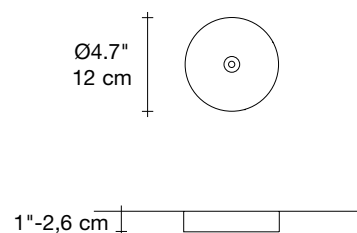

With this light, designer Dodo Arslan creates a shimmering cloud. Argent consists of metal discs that have been meticulously shaped by Terzani craftsmen into clusters. Once lit, the multiple angled surfaces of the discs emanate a soft, shimmering glow. Argent is available in stainless steel, gold, sunset rose, and champagne finishes. Black nickel plated is available on request. Design Dodo Arslan.