

Angel Falls, cast down, *earth.*

design Nigel Coates
terzani.com

TERZANI



Name
Angel Falls
7 pendants

Materials
clear crystal

Finishes | Code
 clear
 0Q07S H4 A9

Body | 7 angels

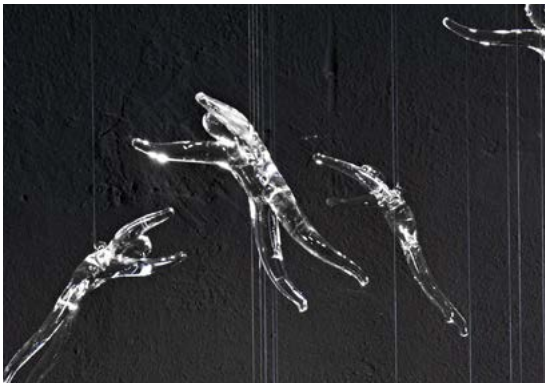
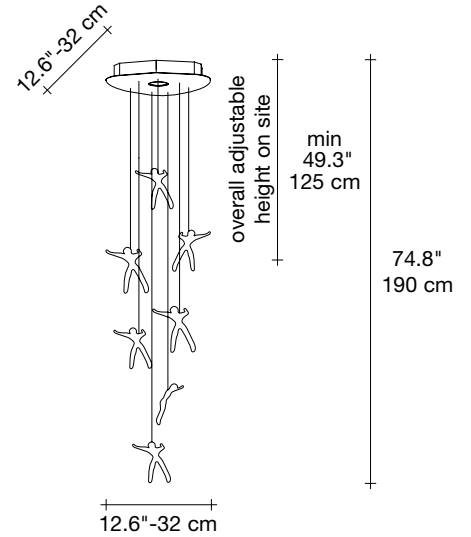

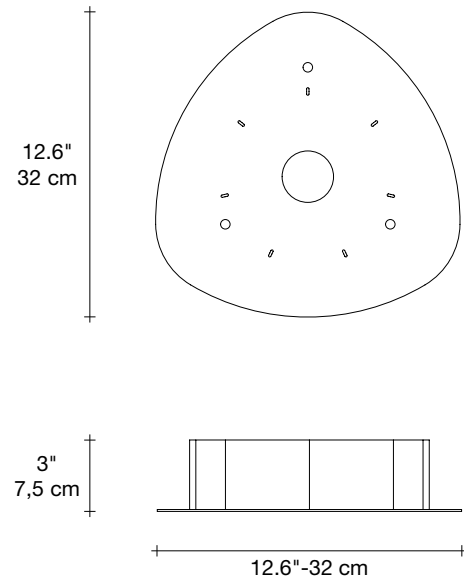

Light source
 120V ~ 50/60Hz
 LED
 7W GU10 dimmable
dimmable options
 all systems

Canopy | brushed nickel plated



For his work with Terzani, Nigel Coates, well known for his unorthodox approach to design, has created an engaging, unique light. Customizable groups of handmade crystal "angels" are illuminated by halogen or led lamps. What caused these angels to fall from the heavens? It's up to the viewers to decide. Either way, Angel Falls is sure to garner attention and generate conversation in any setting. Design Nigel Coates.

 9 lbs
 4,1 kg
  1x 8.8 lbs
 1x 6.6 lbs
 1x 4 kg
 1x 3 kg
  1x 19.7" x 19.7" x 9.8"
 1x 19.7" x 19.7" x 9.8"
 1x 50 x 50 x 25 cm
 1x 50 x 50 x 25 cm

Angel Falls, cast down, *earth.*

design Nigel Coates
terzani.com

TERZANI



Name
Angel Falls
12 pendants

Materials
clear crystal

Finishes | Code
 clear
 OQ12S H4 A9

Body | 12 angels

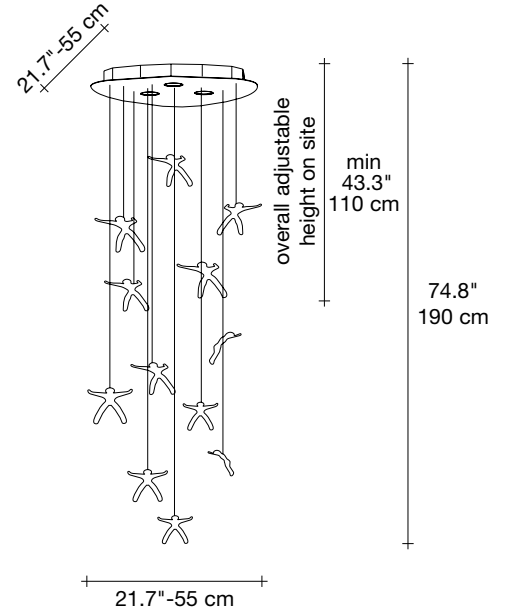

Light source
120V ~ 50/60Hz

 LED
3 x 7W GU10 dimmable



dimmable options

 all systems

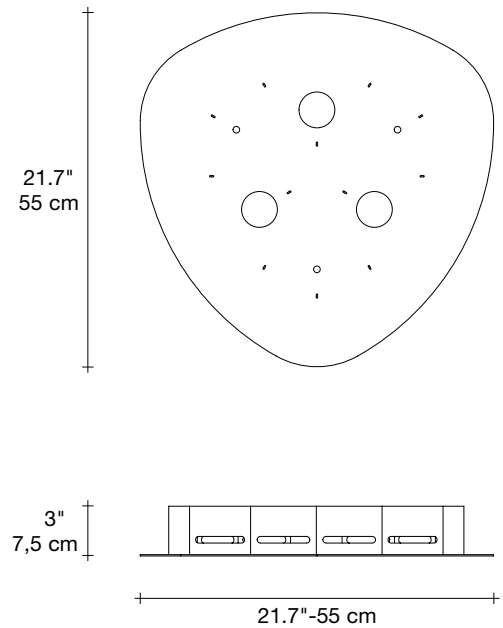
Canopy | brushed nickel plated



For his work with Terzani, Nigel Coates, well known for his unorthodox approach to design, has created an engaging, unique light. Customizable groups of handmade crystal "angels" are illuminated by halogen or led lamps. What caused these angels to fall from the heavens? It's up to the viewers to decide. Either way, Angel Falls is sure to garner attention and generate conversation in any setting. Design Nigel Coates.

 19.8 lbs	 1x 19.8 lbs	 1x 26.4" x 26.4" x 9.1"
9 kg	1x 13.2 lbs	1x 26.4" x 26.4" x 11.8"
	1x 9 kg	1x 67 x 67 x 23 cm
	1x 6 kg	1x 67 x 67 x 30 cm

Angel Falls, cast down, *earth.*

design Nigel Coates
terzani.com

TERZANI



Name
Angel Falls
18 pendants

Materials
clear crystal

Finishes | Code
 clear
 0Q11S H4 A9

Body | 18 angels

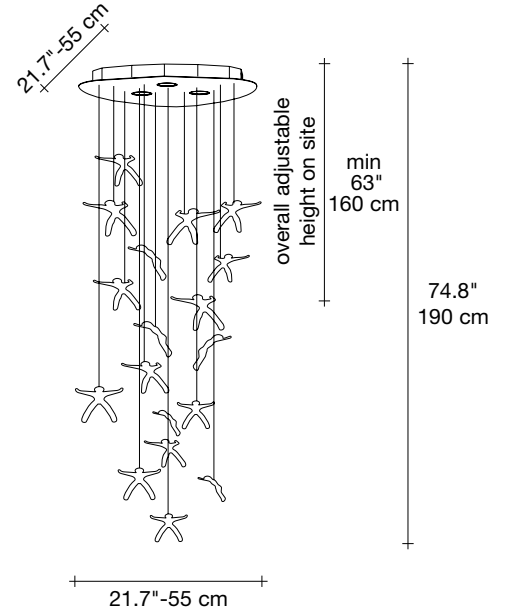

Light source
120V ~ 50/60Hz

 LED
3 x 7W GU10 dimmable







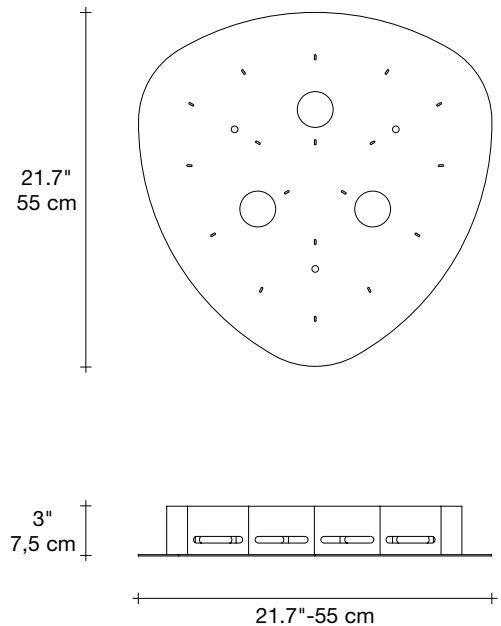



dimmable options

 all systems

Canopy | brushed nickel plated



For his work with Terzani, Nigel Coates, well known for his unorthodox approach to design, has created an engaging, unique light. Customizable groups of handmade crystal "angels" are illuminated by halogen or led lamps. What caused these angels to fall from the heavens? It's up to the viewers to decide. Either way, Angel Falls is sure to garner attention and generate conversation in any setting. Design Nigel Coates.

 22 lbs
 10 kg
  1x 19.8 lbs
 1x 16.5 lbs
 1x 9 kg
 1x 7,5 kg
  1x 26.4" x 26.4" x 9.1"
 1x 26.4" x 26.4" x 11.8"
 1x 67 x 67 x 23 cm
 1x 67 x 67 x 30 cm

Angel Falls, cast down, *earth.*

design Nigel Coates
terzani.com

TERZANI





Name
Angel Falls
24 pendants

Material
clear crystal

Finishes | Code
 clear
 0Q10S H4 A9

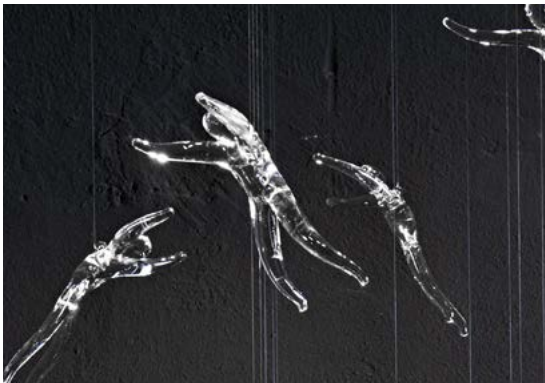
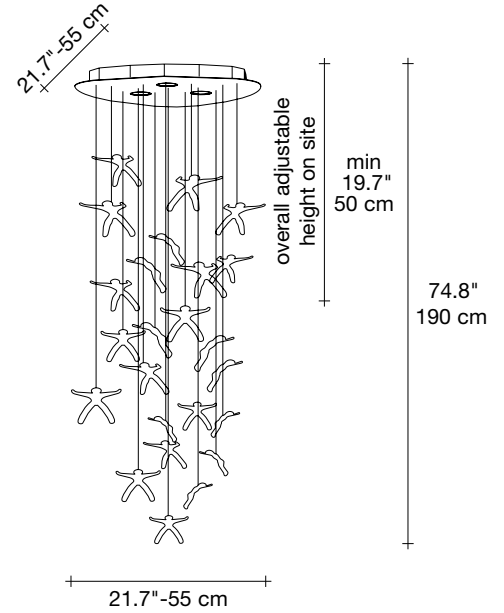
Body | 24 angels



Light source
120V ~ 50/60Hz
 LED
 3 x 7W GU10 dimmable



dimmable options

 all systems

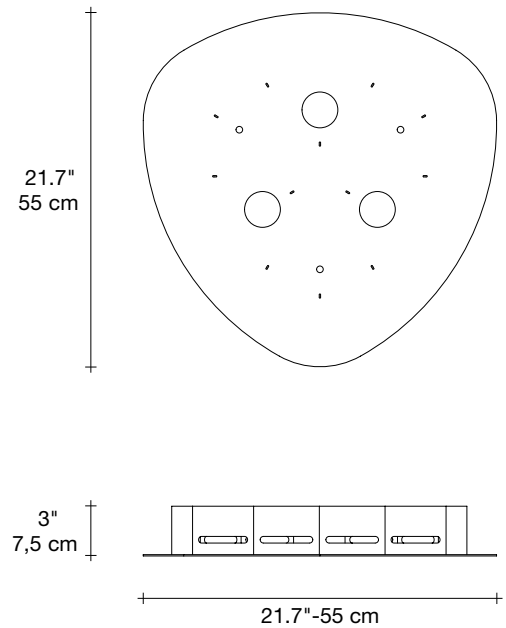
Canopy | brushed nickel plated



For his work with Terzani, Nigel Coates, well known for his unorthodox approach to design, has created an engaging, unique light. Customizable groups of handmade crystal "angels" are illuminated by halogen or led lamps. What caused these angels to fall from the heavens? It's up to the viewers to decide. Either way, Angel Falls is sure to garner attention and generate conversation in any setting. Design Nigel Coates.

 30.8 lbs
 14 kg
 1x 22 lbs
 1x 31.7 lbs
 1x 10 kg
 1x 14,4 kg
 1x 26.4" x 26.4" x 11.8"
 1x 30.3" x 30.3" x 11.8"
 1x 67 x 67 x 30 cm
 1x 77 x 77 x 30 cm

Angel Falls, cast down, *earth.*

design Nigel Coates
terzani.com

TERZANI



Name
Angel Falls
36 pendants

Material
clear crystal

Finishes | Code

 clear
0Q13S E8 A9

Body | 36 angels

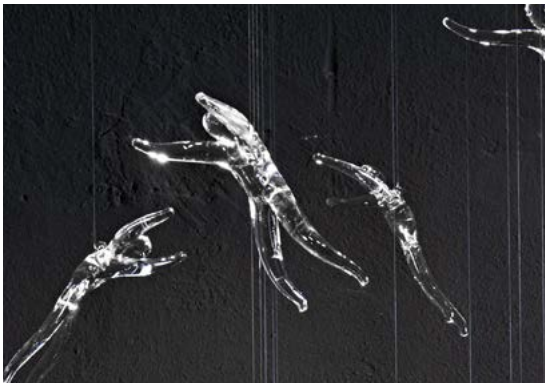
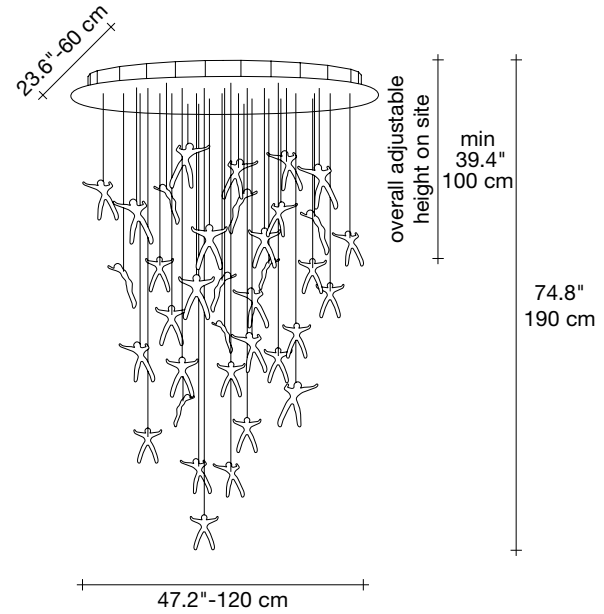

Light source
120V ~ 50/60Hz

 LED
9 x 6W GU10 dimmable



dimmable options

all systems

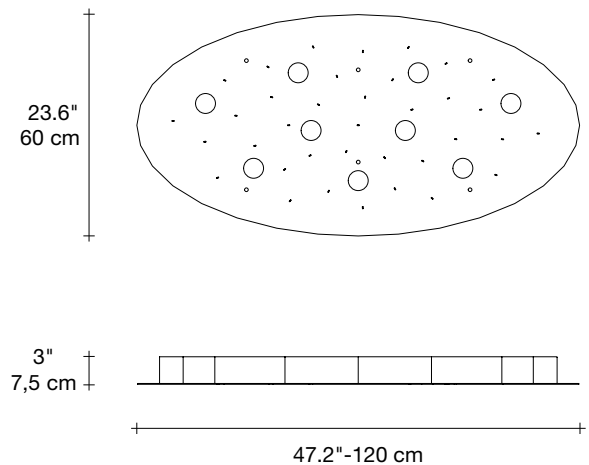
Canopy | white



For his work with Terzani, Nigel Coates, well known for his unorthodox approach to design, has created an engaging, unique light. Customizable groups of handmade crystal "angels" are illuminated by halogen or led lamps. What caused these angels to fall from the heavens? It's up to the viewers to decide. Either way, Angel Falls is sure to garner attention and generate conversation in any setting. Design Nigel Coates.

 55.1 lbs	 1x 41.9 lbs	 1x 51.2" x 33.4" x 8.3"
25 kg	1x 35.3 lbs	1x 32.7" x 31.5" x 17.1"
	1x 19 kg	1x 130 x 85 x 21 cm
	1x 16 kg	1x 83 x 80 x 43,5 cm