

Mizu, flowing *light*.

design Nicolas Terzani
terzani.com

TERZANI







Name
Mizu
pendant light

Materials
crystal

CE ENEC CB

Finishes | Code

-  clear
OR01SE8A9KK
-  champagne
OR01SE8H1KK
-  cognac
OR01SE8H4KK
-  silver dust
OR01SE8F4KK
-  gold
OR01SE8A4KK

Body

NO DRIVER INCLUDED

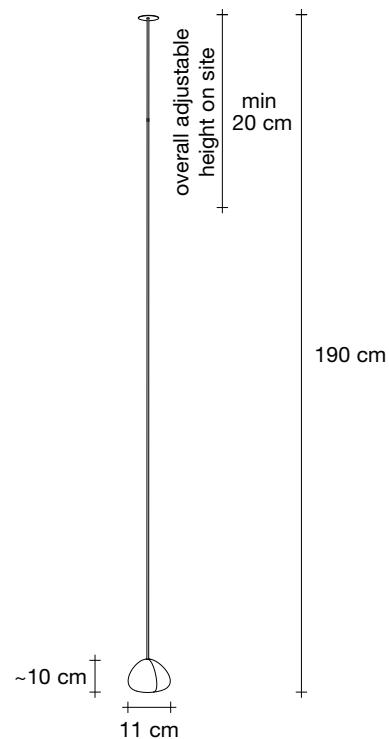

Light source options

12V ~ 50/60Hz

 HALOGEN
10W G4 12V

or

 LED
2W G4 12V

500mA ~ 50/60Hz

Built in Replaceable LED Module
1,5W 174 lm 3000K
or optional 164 lm 2700K

dimmmable drivers available

IGBT
10-100kΩ
0/1-10V
PUSH
DALI

Disc | white

0,6 cm 

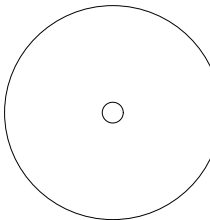
Ø5 cm 

Inspired by the tranquil and mesmerizing light refractions created by water, Mizu is a customizable pendant light from Terzani. Like water droplets, no two Mizu are alike; each crystal shape is unique and meticulously handmade. Using only the clearest crystal, Mizu perfectly emulates water's refraction of light, casting amazing patterns around the room, reminiscent of flowing water. Available in clear, silver dust, gold, cognac, and champagne finish. Design Nicolas Terzani.

Mizu, flowing light.

design Nicolas Terzani
terzani.com

TERZANI



Name
Mizu
pendant light

Materials
crystal

CE ENEC CB

Finishes | Code

-  clear
OR01SE8A9
-  champagne
OR01SE8H1
-  cognac
OR01SE8H4
-  silver dust
OR01SE8F4
-  gold
OR01SE8A4

Body

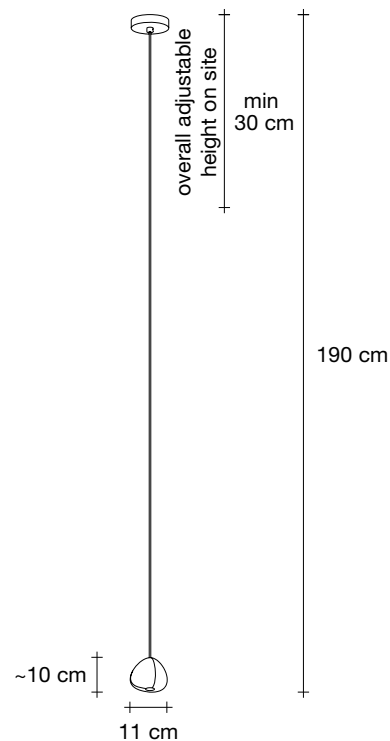

Light source options

230-240V ~ 50/60Hz

 HALOGEN
10W G4 12V

or

 LED
2W G4 12V
3W G4 12V

or

 Built in Replaceable LED Module
1,5W 174 lm 3000K
or optional 164 lm 2700K

dimnable options

 not dimmable

 IGBT
TRIAC
DALI

Inspired by the tranquil and mesmerizing light refractions created by water, Mizu is a customizable pendant light from Terzani. Like water droplets, no two Mizu are alike; each crystal shape is unique and meticulously handmade. Using only the clearest crystal, Mizu perfectly emulates water's refraction of light, casting amazing patterns around the room, reminiscent of flowing water. Available in clear, silver dust, gold, cognac, and champagne finish. Design Nicolas Terzani.

Canopy | white

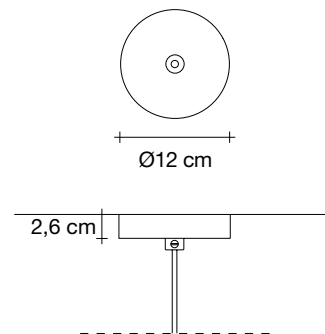

Canopy for DALI | white *

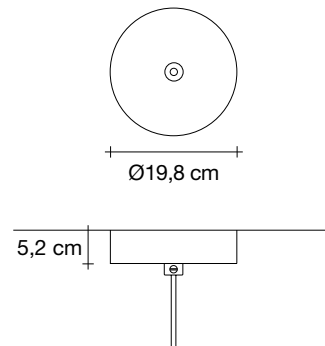

Mizu, flowing *light*.

design Nicolas Terzani
terzani.com

TERZANI







Name
Mizu
3 light pendant

Materials
crystal

CE ENEC CB

Finishes | Code

-  clear
OR03SE8A9
-  champagne
OR03SE8H1
-  cognac
OR03SE8H4
-  silver dust
OR03SE8F4
-  gold
OR03SE8A4

Body

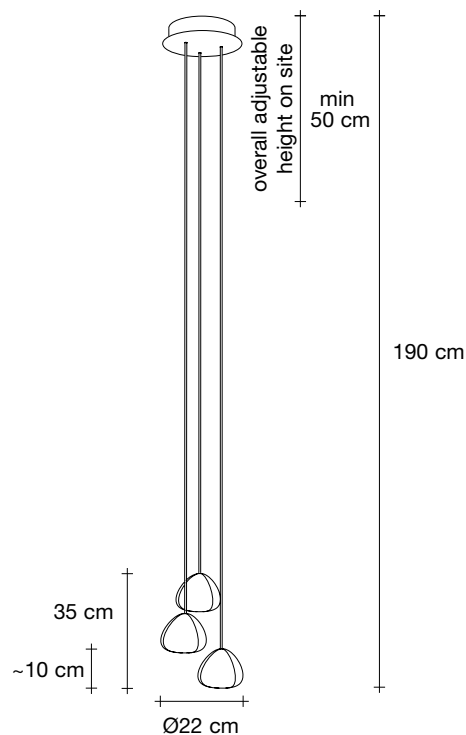

Light source options

230-240V ~ 50/60Hz

 HALOGEN
3 × 10W G4 12V

or

 LED
3 × 2W G4 12V

or

 Built in Replaceable LED Module
3 × 1,5W 522 lm 3000K
or optional 492 lm 2700K

dimnable options

 not dimmable

 IGBT
1-10V
PUSH
DALI

Canopy | white

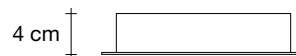
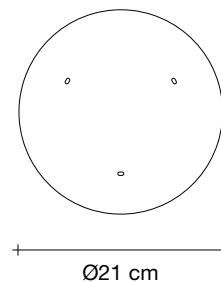

Inspired by the tranquil and mesmerizing light refractions created by water, Mizu is a customizable pendant light from Terzani. Like water droplets, no two Mizu are alike; each crystal shape is unique and meticulously handmade. Using only the clearest crystal, Mizu perfectly emulates water's refraction of light, casting amazing patterns around the room, reminiscent of flowing water. Available in clear, silver dust, gold, cognac, and champagne finish. Design Nicolas Terzani.

Mizu, flowing *light*.

design Nicolas Terzani
terzani.com

TERZANI



Name
Mizu
5 light pendant

Materials
crystal

CE ENEC CB

Finishes | Code

-  clear
OR05SE8A9
-  champagne
OR05SE8H1
-  cognac
OR05SE8H4
-  silver dust
OR05SE8F4
-  gold
OR05SE8A4

Body

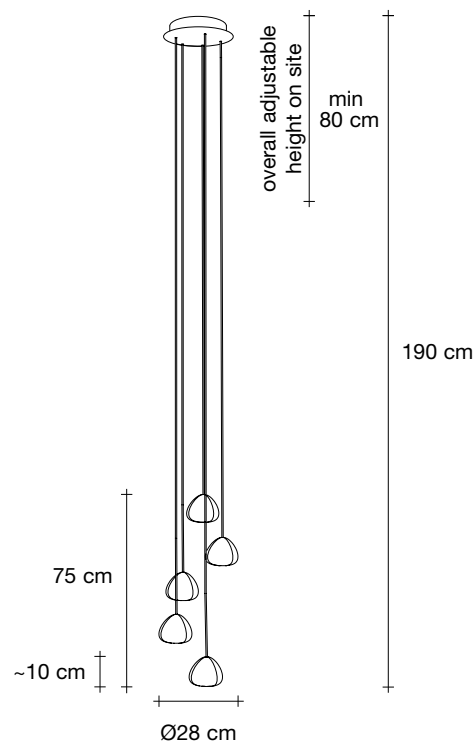

Light source options

230-240V ~ 50/60Hz

 HALOGEN
5 × 10W G4 12V

or

 LED
5 × 2W G4 12V

or

 Built in Replaceable LED Module
5 × 1,5W 870 lm 3000K
or optional 820 lm 2700K

dimnable options

 IGBT
0/1-10V
PWM
PUSH
DALI

Canopy | white

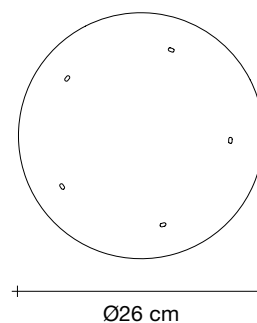

Inspired by the tranquil and mesmerizing light refractions created by water, Mizu is a customizable pendant light from Terzani. Like water droplets, no two Mizu are alike; each crystal shape is unique and meticulously handmade. Using only the clearest crystal, Mizu perfectly emulates water's refraction of light, casting amazing patterns around the room, reminiscent of flowing water. Available in clear, silver dust, gold, cognac, and champagne finish. Design Nicolas Terzani.

Mizu, flowing light.

design Nicolas Terzani
terzani.com

TERZANI



Name
Mizu
7 light pendant

Materials
crystal

CE ENEC CB

Finishes | Code

-  clear
OR07SE8A9
-  champagne
OR07SE8H1
-  cognac
OR07SE8H4
-  silver dust
OR07SE8F4
-  gold
OR07SE8A4

Body

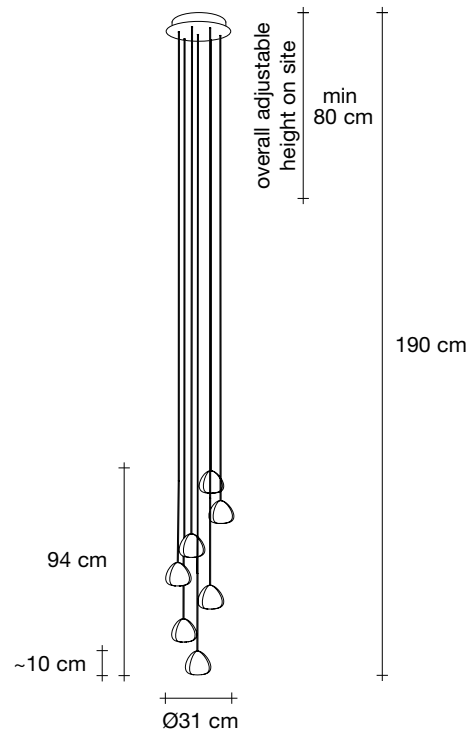

Light source options

230-240V ~ 50/60Hz

 HALOGEN
7 x 10W G4 12V

or

 LED
7 x 2W G4 12V

or

 Built in Replaceable LED Module
7 x 1,5W 1218 lm 3000K
or optional 1148 lm 2700K

dimnable options

 IGBT
0/1-10V
PWM
PUSH
DALI

Canopy | white

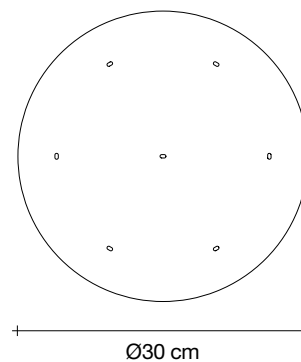

Inspired by the tranquil and mesmerizing light refractions created by water, Mizu is a customizable pendant light from Terzani. Like water droplets, no two Mizu are alike; each crystal shape is unique and meticulously handmade. Using only the clearest crystal, Mizu perfectly emulates water's refraction of light, casting amazing patterns around the room, reminiscent of flowing water. Available in clear, silver dust, gold, cognac, and champagne finish. Design Nicolas Terzani.

Mizu, flowing *light*.

design Nicolas Terzani
terzani.com

TERZANI







Name
Mizu
15 rectangular multi light pendant

Materials
crystal

CE ENEC CB

Finishes | Code

-  clear
OR15SE8A9R
-  champagne
OR15SE8H1R
-  cognac
OR15SE8H4R
-  silver dust
OR15SE8F4R
-  gold
OR15SE8A4R

Body

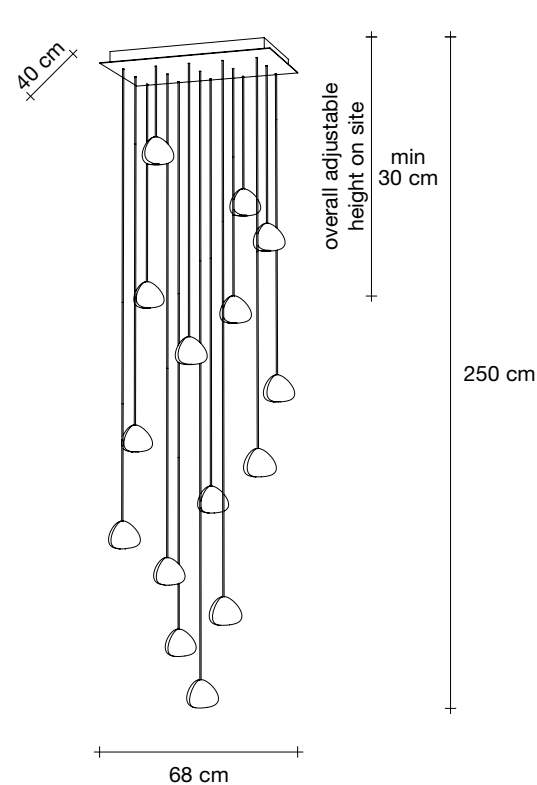

Light source options

230-240V ~ 50/60Hz

 HALOGEN
15 x 10W G4 12V

or

 LED
15 x 2W G4 12V

or

 Built in Replaceable LED Module
15 x 1,5W 2610 lm 3000K
or optional 2460 lm 2700K

dimming options

-  IGBT
0/1-10V
PWM
PUSH
DALI

Canopy | white

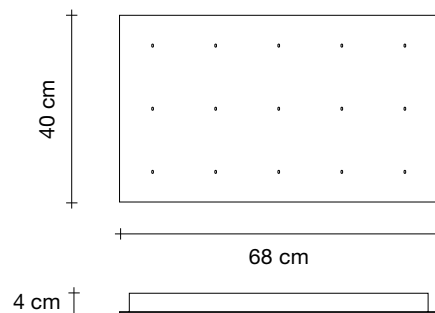

Inspired by the tranquil and mesmerizing light refractions created by water, Mizu is a customizable pendant light from Terzani. Like water droplets, no two Mizu are alike; each crystal shape is unique and meticulously handmade. Using only the clearest crystal, Mizu perfectly emulates water's refraction of light, casting amazing patterns around the room, reminiscent of flowing water. Available in clear, silver dust, gold, cognac, and champagne finish. Design Nicolas Terzani.

Mizu, flowing *light.*

design Nicolas Terzani
terzani.com

TERZANI







Name
Mizu
15 round multi light pendant

Materials
crystal

CE ENEC CB

Finishes | Code

-  clear
OR15SE8A9T
-  champagne
OR15SE8H1T
-  cognac
OR15SE8H4T
-  silver dust
OR15SE8F4T
-  gold
OR15SE8A4T

Body

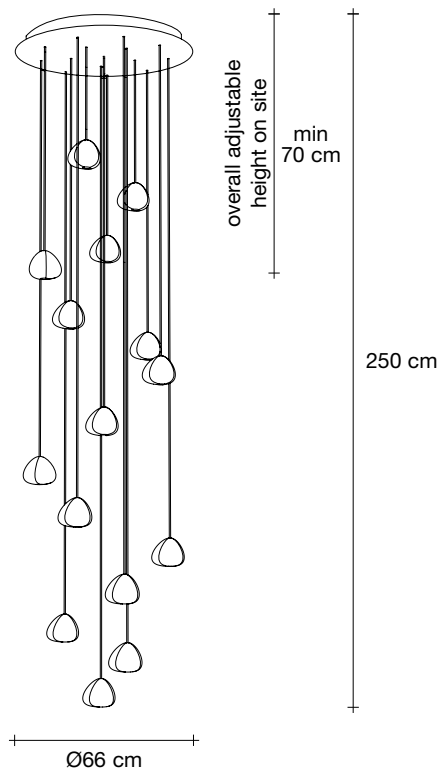

Light source options

230-240V ~ 50/60Hz

 HALOGEN
15 x 10W G4 12V

or

 LED
15 x 2W G4 12V

or

 Built in Replaceable LED Module
15 x 1,5W 2610 lm 3000K
or optional 2460 lm 2700K

dimming options

 IGBT
0/1-10V
PWM
PUSH
DALI

Canopy | white

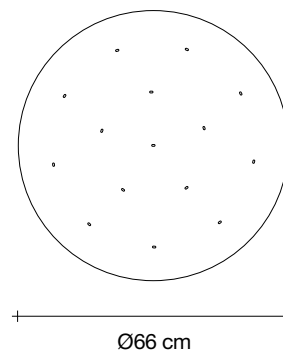

4 cm 

Inspired by the tranquil and mesmerizing light refractions created by water, Mizu is a customizable pendant light from Terzani. Like water droplets, no two Mizu are alike; each crystal shape is unique and meticulously handmade. Using only the clearest crystal, Mizu perfectly emulates water's refraction of light, casting amazing patterns around the room, reminiscent of flowing water. Available in clear, silver dust, gold, cognac, and champagne finish. Design Nicolas Terzani.

Mizu, flowing *light*.

design Nicolas Terzani
terzani.com

TERZANI







Name
Mizu
26 square multi light pendant

Materials
crystal

CE ENEC CB

Finishes | Code

-  clear
OR26SE8A9Q
-  champagne
OR26SE8H1Q
-  cognac
OR26SE8H4Q
-  silver dust
OR26SE8F4Q
-  gold
OR26SE8A4Q

Body

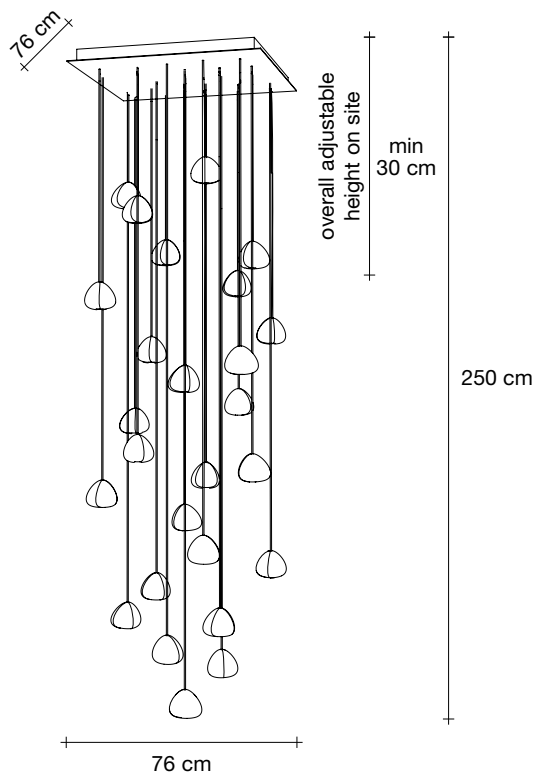

Light source options

230-240V ~ 50/60Hz

 HALOGEN
26 x 10W G4 12V

or

 LED
26 x 2W G4 12V

or

 Built in Replaceable LED Module
26 x 1,5W 4524 lm 3000K
or optional 4264 lm 2700K

dimming options

 IGBT
0/1-10V
PWM
PUSH
DALI

Canopy | white

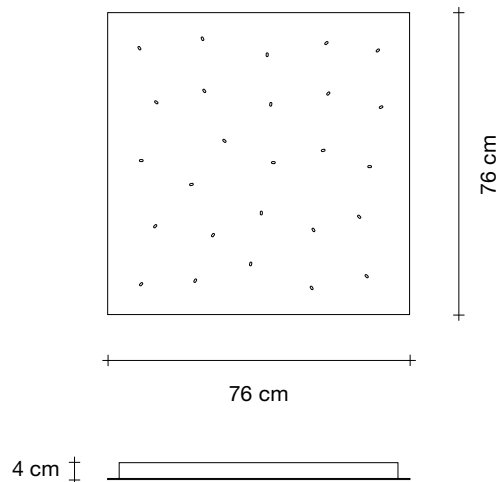

Inspired by the tranquil and mesmerizing light refractions created by water, Mizu is a customizable pendant light from Terzani. Like water droplets, no two Mizu are alike; each crystal shape is unique and meticulously handmade. Using only the clearest crystal, Mizu perfectly emulates water's refraction of light, casting amazing patterns around the room, reminiscent of flowing water. Available in clear, silver dust, gold, cognac, and champagne finish. Design Nicolas Terzani.

Mizu, flowing *light*.

design Nicolas Terzani
terzani.com

TERZANI







Name
Mizu
26 round multi light pendant

Materials
crystal

CE ENEC CB

Finishes | Code

-  clear
OR26SE8A9T
-  champagne
OR26SE8H1T
-  cognac
OR26SE8H4T
-  silver dust
OR26SE8F4T
-  gold
OR26SE8A4T

Body

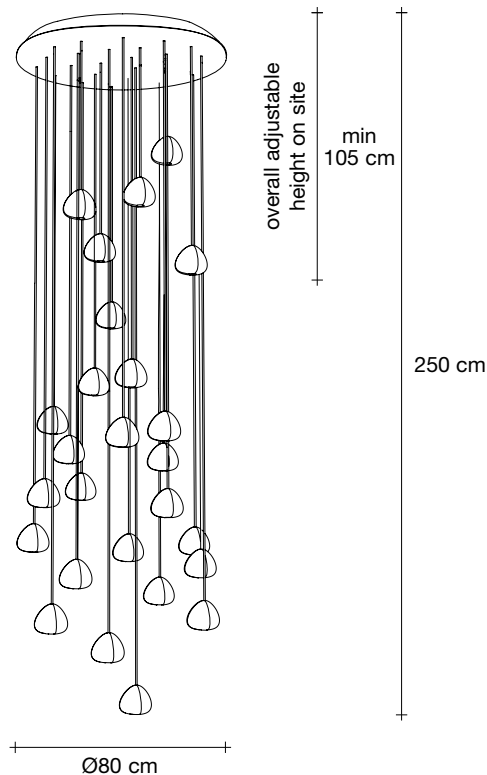

Light source options

230-240V ~ 50/60Hz

 HALOGEN
26 x 10W G4 12V

or

 LED
26 x 2W G4 12V

or

 Built in Replaceable LED Module
26 x 1,5W 4524 lm 3000K
or optional 4264 lm 2700K

dimnable options

 IGBT
0/1-10V
PWM
PUSH
DALI

Canopy | white

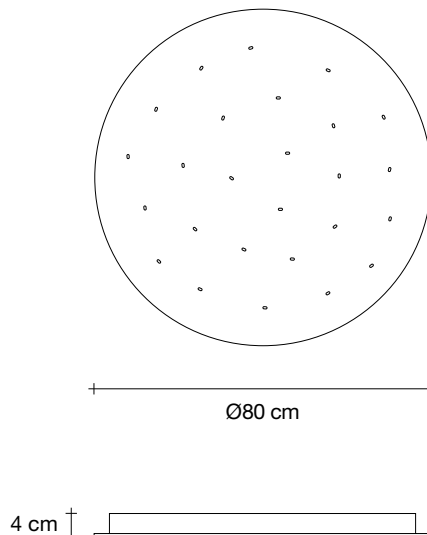

Inspired by the tranquil and mesmerizing light refractions created by water, Mizu is a customizable pendant light from Terzani. Like water droplets, no two Mizu are alike; each crystal shape is unique and meticulously handmade. Using only the clearest crystal, Mizu perfectly emulates water's refraction of light, casting amazing patterns around the room, reminiscent of flowing water. Available in clear, silver dust, gold, cognac, and champagne finish. Design Nicolas Terzani.