

Genesis, floating knit

design Gianluca Regazzo
terzani.com



TERZANI



Name
Genesis

Materials
stainless steel
brass

Finishes | Code

-  stainless steel
OB55SE7H90
-  brass
OB55SL6N50

Body

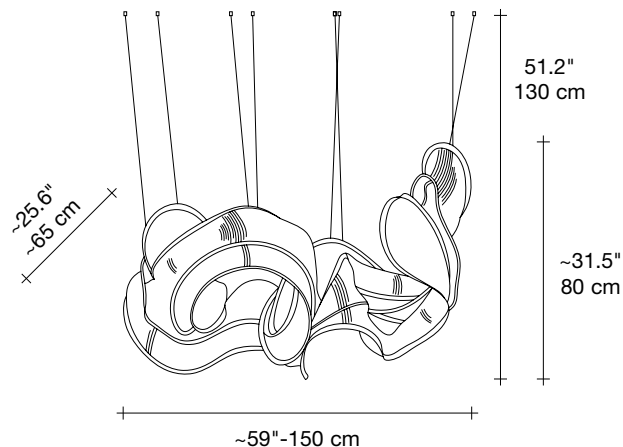

On-site adjustable overall length: 51.2"-67"/130-170 cm
On-site adjustable overall height: 55"-70.8"/100-140 cm

Due to its artistic and handcrafted nature, each Genesis installation is a unique creation. While the design principles remain consistent, slight variations in shape, movement, and behavior ensure that every piece is truly one of a kind. These differences contribute to the individuality and character of each installation, making Genesis a dynamic work of art.

Gianluca Regazzo has woven his vision, inspired by the language of fashion, into the creation of a fabric suspended in mid-air, blending elegance and creativity into an ethereal and timeless form. Genesis combines textile art and illumination, bringing to life a work that emerges from a slender thread of knitted steel.

Its organic essence transforms into a visual jewel, capable of refracting light in a delicate balance between lightness and harmony, enchanting those who behold it. The transparency of the fabric seems to merge with its surroundings, as if breathing in the surrounding space. Its fluid and intricate weave tells a story of textures that dance ceaselessly between imagination and reality. Genesis is a primordial act, the birth of new life shaped by thread, a creation that reveals itself in constant motion.

Like an ancient tale taking form, it transforms the fabric into an endless narrative, where each weave and thread gives rise to a new shape. It is a living work, evolving and changing, evoking a flow of ethereal forms in which light merges with matter. Genesis dissolves the boundaries between the tangible and the imaginary, between design and art, celebrating the birth of a new existence. Design Gianluca Regazzo. Made in Italy.

Optional Light source: ceiling mounted or recessed downlights

General recommendations:

Number of downlights: 4 to 7
Beam Angle: 45° - 60°
Color Temperature: 2700K - 3000K
Lumen Output: 800 - 1200 lumens per downlight
CRI (Color Rendering Index): ≥90

Specific lighting designs may vary based on the space and desired atmosphere.

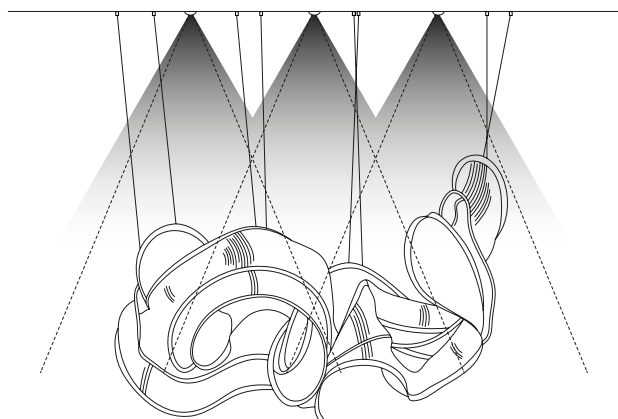

 3.3 lbs
1,5 kg

 6.2 lbs
2,8 kg

 30.3" x 13.8" x 10.4"
77 x 35 x 26,5 cm

Genesis, floating knit

design Gianluca Regazzo
terzani.com

TERZANI





Name

Genesis double linear
suspended sculpture

Materials

stainless steel
brass

Finishes | Code

-  stainless steel
OB56SE7H90
-  brass
OB56SL6N50

Body

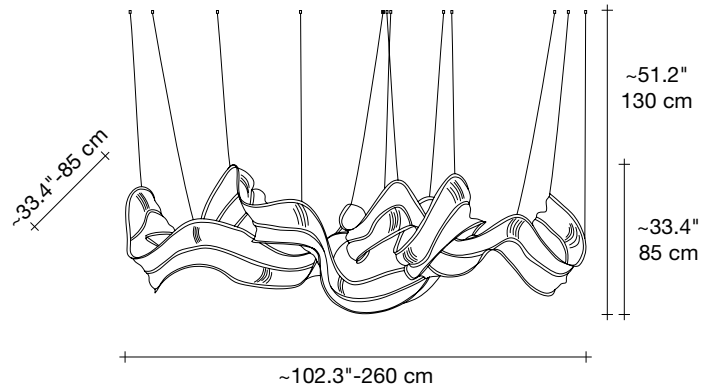

On-site adjustable overall length: 94.4"-118"/240-300 cm
On-site adjustable overall height: 55"-70.8"/100-140 cm

Due to its artistic and handcrafted nature, each Genesis installation is a unique creation. While the design principles remain consistent, slight variations in shape, movement, and behavior ensure that every piece is truly one of a kind. These differences contribute to the individuality and character of each installation, making Genesis a dynamic work of art.

Gianluca Regazzo has woven his vision, inspired by the language of fashion, into the creation of a fabric suspended in mid-air, blending elegance and creativity into an ethereal and timeless form. Genesis combines textile art and illumination, bringing to life a work that emerges from a slender thread of knitted steel.

Its organic essence transforms into a visual jewel, capable of refracting light in a delicate balance between lightness and harmony, enchanting those who behold it. The transparency of the fabric seems to merge with its surroundings, as if breathing in the surrounding space. Its fluid and intricate weave tells a story of textures that dance ceaselessly between imagination and reality. Genesis is a primordial act, the birth of new life shaped by thread, a creation that reveals itself in constant motion.

Like an ancient tale taking form, it transforms the fabric into an endless narrative, where each weave and thread gives rise to a new shape. It is a living work, evolving and changing, evoking a flow of ethereal forms in which light merges with matter. Genesis dissolves the boundaries between the tangible and the imaginary, between design and art, celebrating the birth of a new existence. Design Gianluca Regazzo. Made in Italy.



Optional Light source: ceiling mounted or recessed downlights

General recommendations:

- Number of downlights: 7 to 9
- Beam Angle: 45° - 60°
- Color Temperature: 2700K - 3000K
- Lumen Output: 800 - 1200 lumens per downlight
- CRI (Color Rendering Index): ≥90

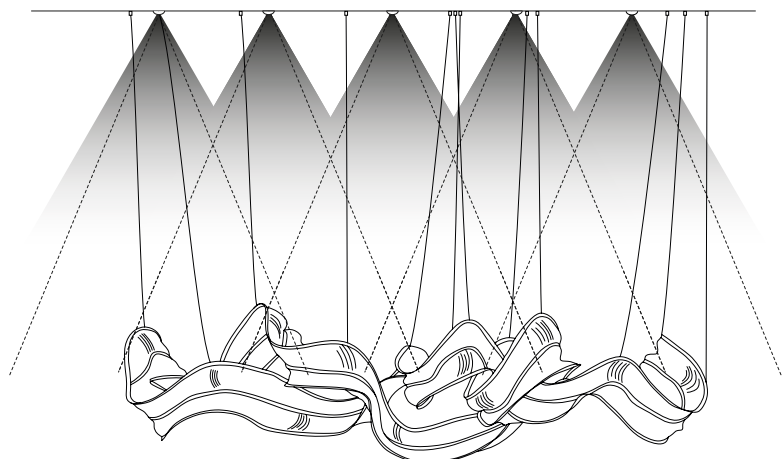
Specific lighting designs may vary based on the space and desired atmosphere.



-  5.7 lbs
2,6 kg
-  10.5 lbs
4,8 kg
-  63.8" × 13.8" × 13.8"
162 × 35 × 35 cm

Genesis, floating knit

design Gianluca Regazzo
terzani.com

TERZANI





Name

Genesis vertical suspended sculpture

Materials

stainless steel
brass

Finishes | Code

-  stainless steel
OB60SE7H9O
-  brass
OB60SL6N5O

Body

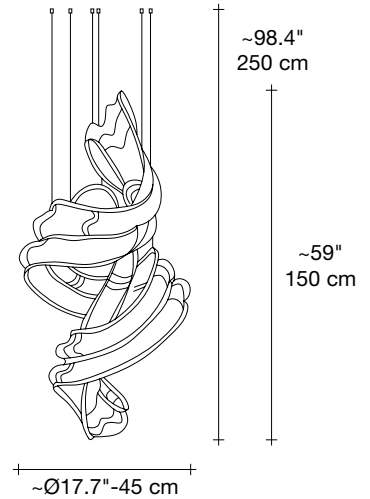

On-site adjustable overall sculpture height: 55"-70.8"/140-180 cm
On-site adjustable overall height: 94.4"-118"/240-300 cm

Due to its artistic and handcrafted nature, each Genesis installation is a unique creation. While the design principles remain consistent, slight variations in shape, movement, and behavior ensure that every piece is truly one of a kind. These differences contribute to the individuality and character of each installation, making Genesis a dynamic work of art.

Gianluca Regazzo has woven his vision, inspired by the language of fashion, into the creation of a fabric suspended in mid-air, blending elegance and creativity into an ethereal and timeless form. Genesis combines textile art and illumination, bringing to life a work that emerges from a slender thread of knitted steel.

Its organic essence transforms into a visual jewel, capable of refracting light in a delicate balance between lightness and harmony, enchanting those who behold it. The transparency of the fabric seems to merge with its surroundings, as if breathing in the surrounding space. Its fluid and intricate weave tells a story of textures that dance ceaselessly between imagination and reality. Genesis is a primordial act, the birth of new life shaped by thread, a creation that reveals itself in constant motion.

Like an ancient tale taking form, it transforms the fabric into an endless narrative, where each weave and thread gives rise to a new shape. It is a living work, evolving and changing, evoking a flow of ethereal forms in which light merges with matter. Genesis dissolves the boundaries between the tangible and the imaginary, between design and art, celebrating the birth of a new existence. Design Gianluca Regazzo. Made in Italy.



Optional Light source: ceiling mounted or recessed downlights

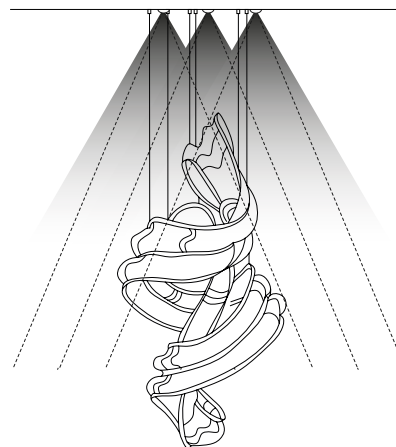

General recommendations:

Number of downlights: 3 to 4
Beam Angle: 45° - 60°
Color Temperature: 2700K - 3000K
Lumen Output: 800 - 1200 lumens per downlight
CRI (Color Rendering Index): ≥90

Specific lighting designs may vary based on the space and desired atmosphere.



 3.3 lbs
 6.2 lbs
 30.3" x 13.8" x 10.4"

 1,5 kg
 2,8 kg
 77 x 35 x 26,5 cm