

Gaia, earth mother.

design Jean-François Crochet
terzani.com

TERZANI



Name
Gaia
linear chandelier

Materials
raw metal | raw brass

Finishes | Code

-  nickel plated
OG41SE7C8
-  gold plated
OG41SL6C8
-  matte walnut
OG41SP2C8

Body

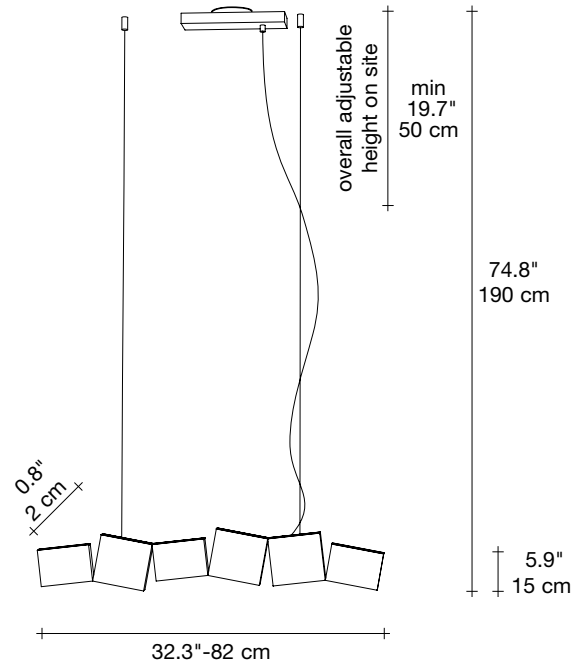

Light source
120V ~ 50/60Hz

-  Built in Replaceable LED Module
12 x 1.5W 1752 lm 3000K
or optional 1548 lm 2700K

dimming options

-  1-10V
PUSH

Canopy | white

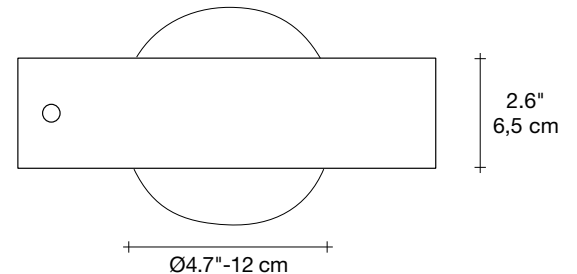
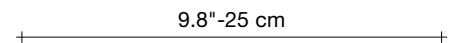
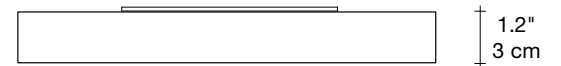

In Greek mythology, Gaia is the personification of the Earth and the mother of all life. Looking to capture the mythical and natural beauty of this Earth goddess, designer Jean-François Crochet has created the Gaia pendant light. Consisting of geometric frames reminiscent of the mountains Gaia created, the pendant uses led light to push light through the "cracks" formed. The resulting light creates a magical feeling, as if the lights peeking through were alive themselves. Also available in gold, nickel, and wood finish and in custom configurations, Gaia adds a vibrancy and sacred light to any space. Design Jean-François Crochet.

Gaia, earth mother.

design Jean-François Crochet
terzani.com

TERZANI



Name
Gaia
double linear chandelier

Materials
raw metal | raw brass

Finishes | Code

-  nickel plated
OG40SE7C8
-  gold plated
OG40SL6C8
-  matte walnut
OG40SP2C8

Body

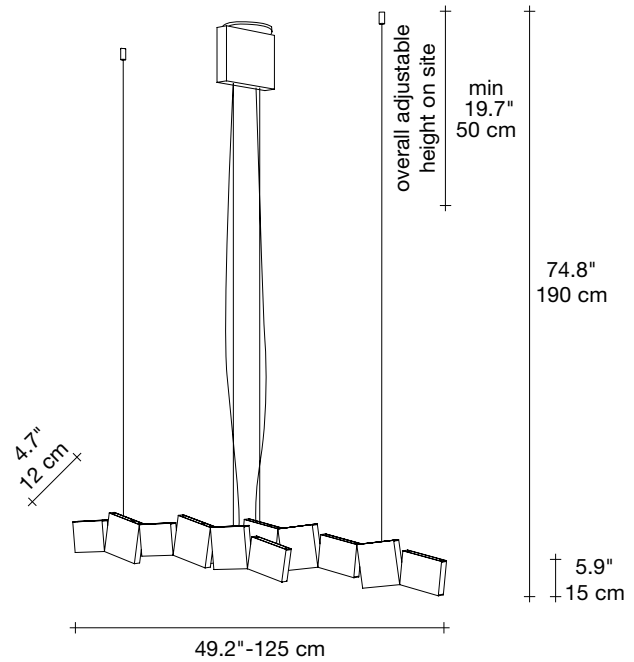

Light source
120V ~ 50/60Hz

-  Built in Replaceable LED Module
24 x 1.5W 3504 lm 3000K
or optional 3096 lm 2700K

dimnable options

-  0/1-10V
PUSH
DALI

Canopy | white

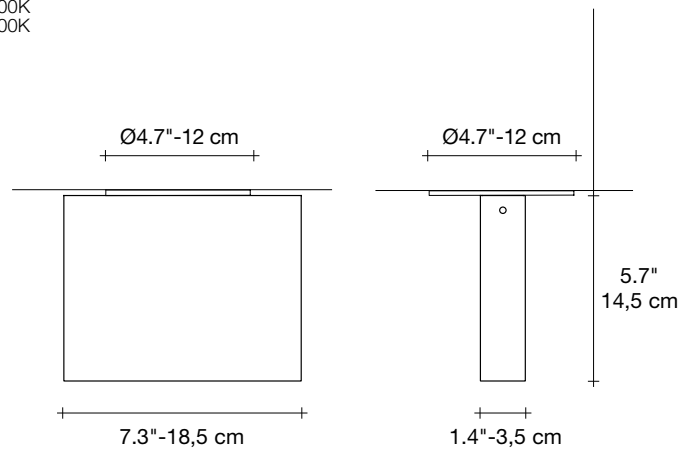

In Greek mythology, Gaia is the personification of the Earth and the mother of all life. Looking to capture the mythical and natural beauty of this Earth goddess, designer Jean-François Crochet has created the Gaia pendant light. Consisting of geometric frames reminiscent of the mountains Gaia created, the pendant uses led light to push light through the "cracks" formed. The resulting light creates a magical feeling, as if the lights peeking through were alive themselves. Also available in gold, nickel, and wood finish and in custom configurations, Gaia adds a vibrancy and sacred light to any space. Design Jean-François Crochet.