

Soscik, classic form, *modern look.*

design Nicolas Terzani
terzani.com

TERZANI



Name
Soscik
small ceiling light

Materials
metal



Finishes | Code

-  nickel plated | brushed nickel plated
OG60L H4 C8
-  brushed bronze
OG60L F7 C8
-  gold plated | brushed gold plated
OG60L L8 C8
-  champagne plated | brushed champagne plated
OG60L N1 C8

Body

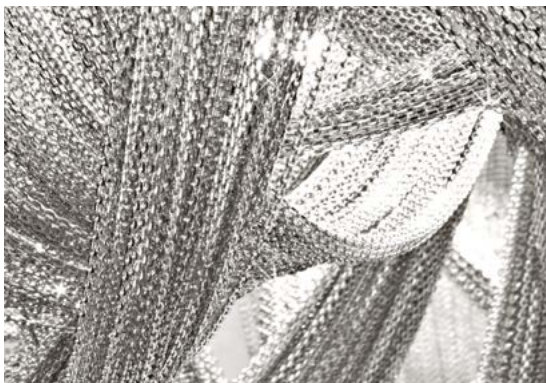
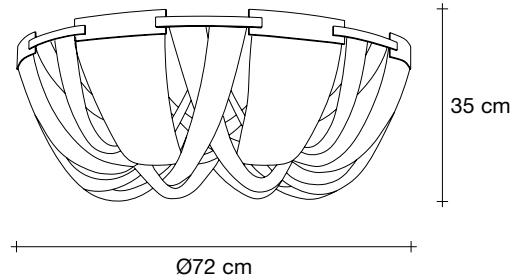

Light source
230-240V ~ 50/60Hz

 LED
8 x 3,5W G9 dimmable

dimmable options

 all systems

Canopy

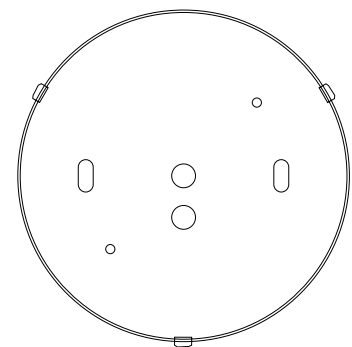
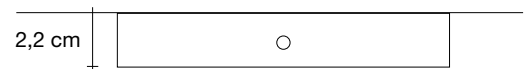

Terzani continues to reinvent the classics with Soscik, which combines traditional artisan techniques with cutting-edge technology to give the traditional chandelier a modern update. Created by interlacing metal chain over the frame, Soscik creates a dramatic and romantic effect while still complementing today's modern luxury. Available as a chandelier or a ceiling lamp, Soscik proves that modern design does not have to sacrifice luxury. Design Nicolas Terzani.

Soscik, classic form, *modern look.*

design Nicolas Terzani
terzani.com

TERZANI



Name
Soscik
medium ceiling light

Materials
metal



Finishes | Code

-  nickel plated | brushed nickel plated
OG61L H4 C8
-  brushed bronze
OG61L F7 C8
-  gold plated | brushed gold plated
OG61L L8 C8
-  champagne plated | brushed champagne plated
OG61L N1 C8

Body

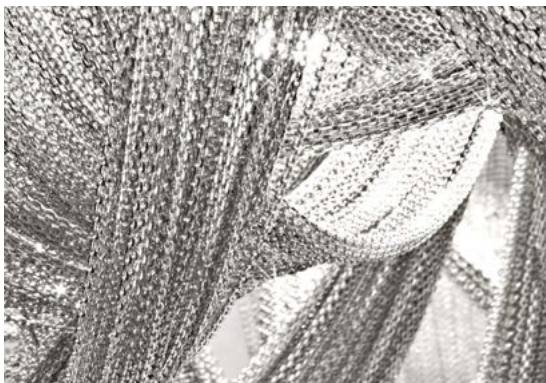
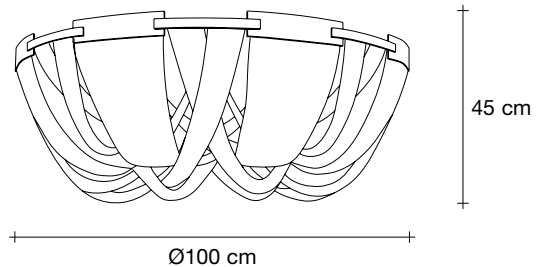

Light source

230-240V ~ 50/60Hz

 LED
10 x 3,5W G9 dimmable

dimmable options

 all systems

Canopy

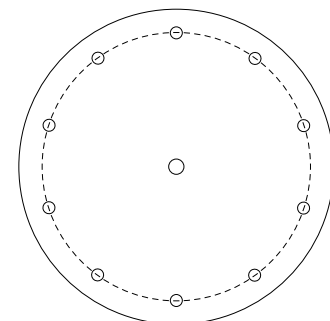

Terzani continues to reinvent the classics with Soscik, which combines traditional artisan techniques with cutting-edge technology to give the traditional chandelier a modern update. Created by interlacing metal chain over the frame, Soscik creates a dramatic and romantic effect while still complementing today's modern luxury. Available as a chandelier or a ceiling lamp, Soscik proves that modern design does not have to sacrifice luxury. Design Nicolas Terzani.

Soscik, classic form, *modern look.*

design Nicolas Terzani
terzani.com

TERZANI



Name
Soscik
large ceiling light

Materials
metal



Finishes | Code

-  nickel plated | brushed nickel plated
OG62L H4 C8
-  brushed bronze
OG62L F7 C8
-  gold plated | brushed gold plated
OG62L L8 C8
-  champagne plated | brushed champagne plated
OG62L N1 C8

Body

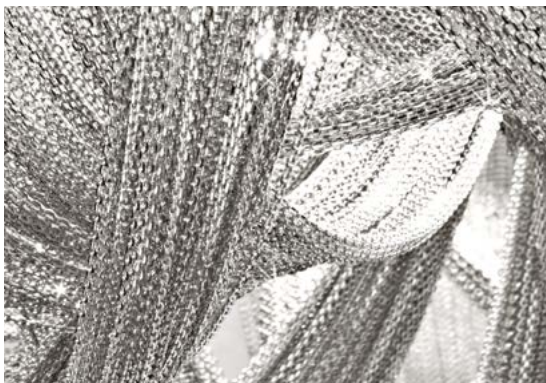
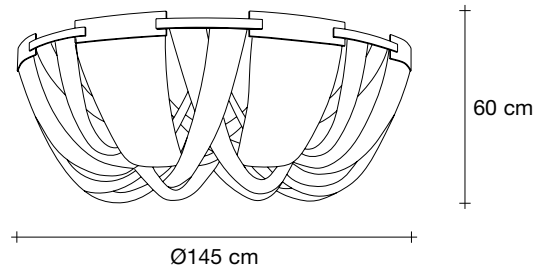

Light source

230-240V ~ 50/60Hz

 LED
12 x 3,5W G9 dimmable

dimmable options

 all systems

Canopy

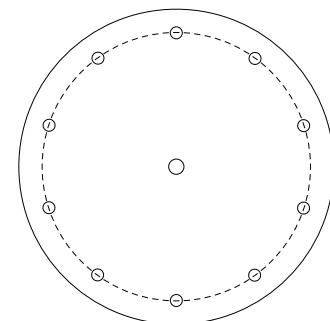

Terzani continues to reinvent the classics with Soscik, which combines traditional artisan techniques with cutting-edge technology to give the traditional chandelier a modern update. Created by interlacing metal chain over the frame, Soscik creates a dramatic and romantic effect while still complementing today's modern luxury. Available as a chandelier or a ceiling lamp, Soscik proves that modern design does not have to sacrifice luxury. Design Nicolas Terzani.

Soscik, classic form, *modern look.*

design Nicolas Terzani
terzani.com

TERZANI



Name
Soscik
small chandelier

Materials
metal



Finishes | Code

-  nickel plated | brushed nickel plated
OG55S H4 C8
-  brushed bronze
OG55S F7 C8
-  gold plated | brushed gold plated
OG55S L8 C8
-  champagne plated | brushed champagne plated
OG55S N1 C8

Body

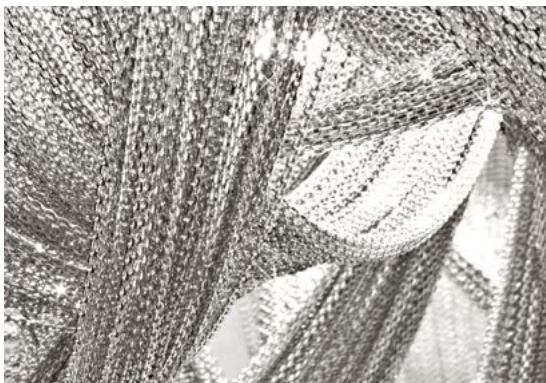
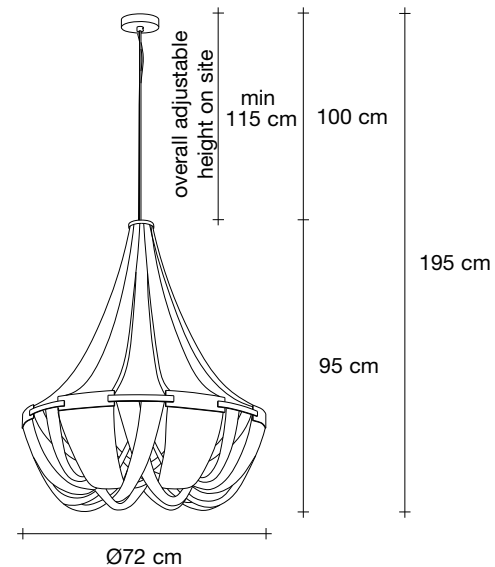

Light source
230-240V ~ 50/60Hz

 LED
8 × 3,5W G9 dimmable

dimmable options

 all systems

Canopy

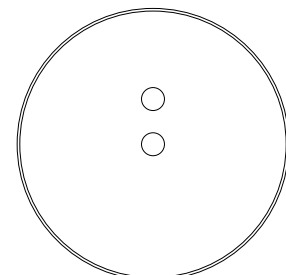

Terzani continues to reinvent the classics with Soscik, which combines traditional artisan techniques with cutting-edge technology to give the traditional chandelier a modern update. Created by interlacing metal chain over the frame, Soscik creates a dramatic and romantic effect while still complementing today's modern luxury. Available as a chandelier or a ceiling lamp, Soscik proves that modern design does not have to sacrifice luxury. Design Nicolas Terzani.

Soscik, classic form, *modern look.*

design Nicolas Terzani
terzani.com

TERZANI



Name
Soscik
medium chandelier

Materials
metal



Finishes | Code

-  nickel plated | brushed nickel plated
OG56S H4 C8
-  brushed bronze
OG56S F7 C8
-  gold plated | brushed gold plated
OG56S L8 C8
-  champagne plated | brushed champagne plated
OG56S N1 C8

Overall height not adjustable on site
optional custom OAH

Body

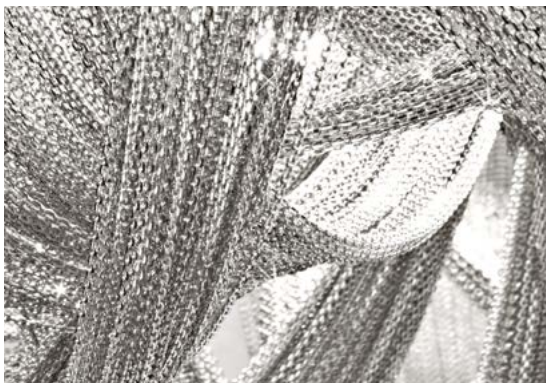
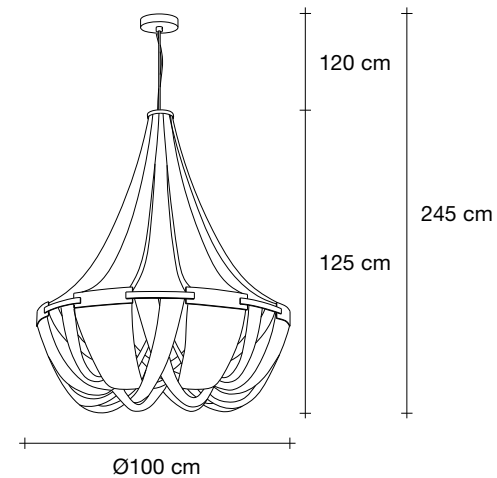

Light source
230-240V ~ 50/60Hz

 LED
12 x 3,5W G9 dimmable

dimmable options

 all systems

Canopy

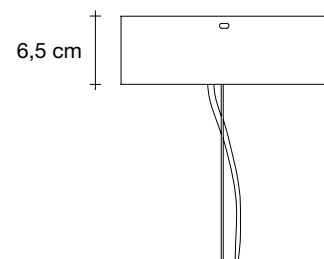
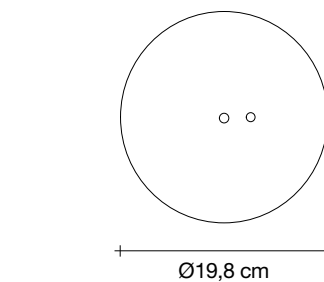

Terzani continues to reinvent the classics with Soscik, which combines traditional artisan techniques with cutting-edge technology to give the traditional chandelier a modern update. Created by interlacing metal chain over the frame, Soscik creates a dramatic and romantic effect while still complementing today's modern luxury. Available as a chandelier or a ceiling lamp, Soscik proves that modern design does not have to sacrifice luxury. Design Nicolas Terzani.

Soscik, classic form, *modern look.*

design Nicolas Terzani
terzani.com

TERZANI



Name
Soscik
large chandelier

Materials
metal



Finishes | Code

-  nickel plated | brushed nickel plated
OG57S H4 C8
-  brushed bronze
OG57S F7 C8
-  gold plated | brushed gold plated
OG57S L8 C8
-  champagne plated | brushed champagne plated
OG57S N1 C8

Body

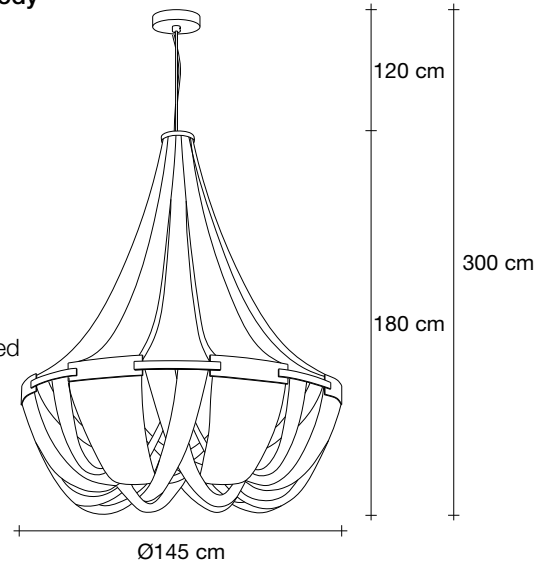

Overall height not adjustable on site
optional custom OAH

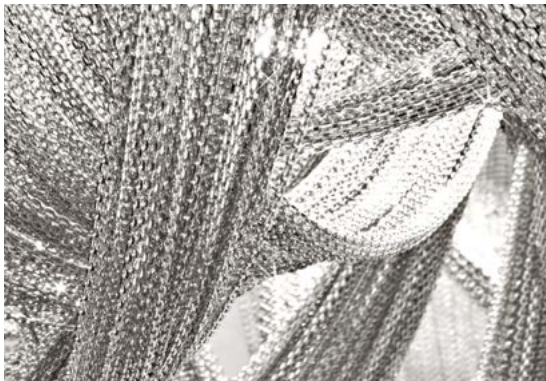

Light source

230-240V ~ 50/60Hz

 LED
14 x 3,5W G9 dimmable

dimmable options

 all systems

Canopy

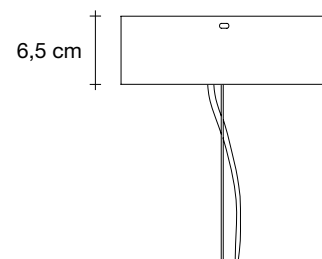
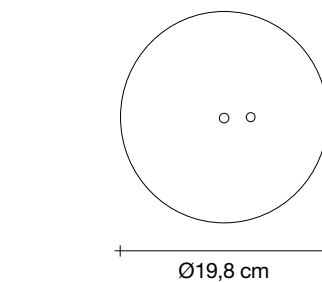

Terzani continues to reinvent the classics with Soscik, which combines traditional artisan techniques with cutting-edge technology to give the traditional chandelier a modern update. Created by interlacing metal chain over the frame, Soscik creates a dramatic and romantic effect while still complementing today's modern luxury. Available as a chandelier or a ceiling lamp, Soscik proves that modern design does not have to sacrifice luxury. Design Nicolas Terzani.