

# Atlantis, a precious *wave*.

design Barlas Baylar  
terzani.com

# TERZANI









**Name**  
Atlantis  
small three tier chandelier

**Materials**  
brass chains | metal  
structure plated as below



### Finishes | Code

-  nickel plated  
0A13SE7C8
-  black nickel plated  
0A13SE9C8
-  brushed bronze  
0A13SF7C8
-  gold plated  
0A13SL6C8
-  champagne plated  
0A13SN1C8
-  brushed champagne plated  
0A13SN7C8

### Body

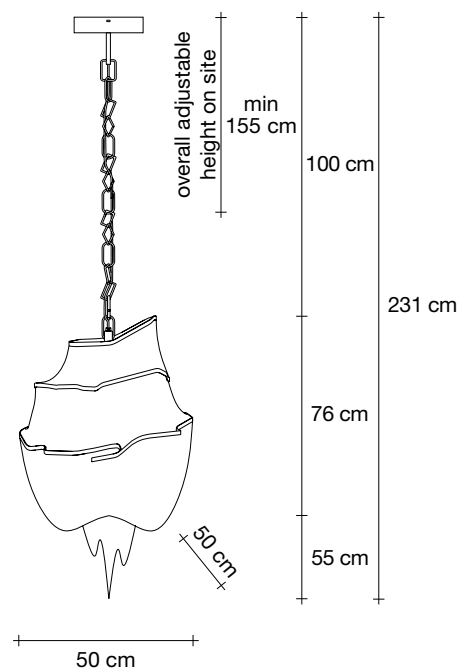

**Light source**  
220-240V ~ 50/60Hz

 led  
6 x 6W E14 dimmable

dimnable options

 all systems

### Canopy

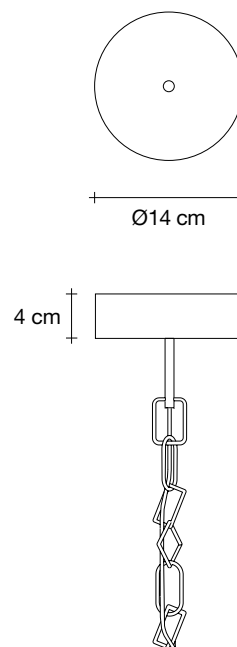

Seemingly alive, Atlantis' shimmering light creates a vibrant source of energy. Its mesmerizing, organic effect is created by hundreds of illuminated lengths of draped chains. Like water in the ocean, Atlantis's chains appear liquid, cascading over its gloss bands and falling down towards the abyss before turning back into itself. Atlantis is composed of almost three miles of chain, meticulously hand-crafted by master Italian artisans. Design Barlas Baylar.

# Atlantis, a precious *wave*.

design Barlas Baylar  
terzani.com

# TERZANI



**Name**  
Atlantis  
medium three tier chandelier

**Materials**  
brass chains | metal  
structure plated as below



### Finishes | Code

-  nickel plated  
0A14SE7C8
-  black nickel plated  
0A14SE9C8
-  brushed bronze  
0A14SF7C8
-  gold plated  
0A14SL6C8
-  champagne plated  
0A14SN1C8
-  brushed champagne plated  
0A14SN7C8

### Body

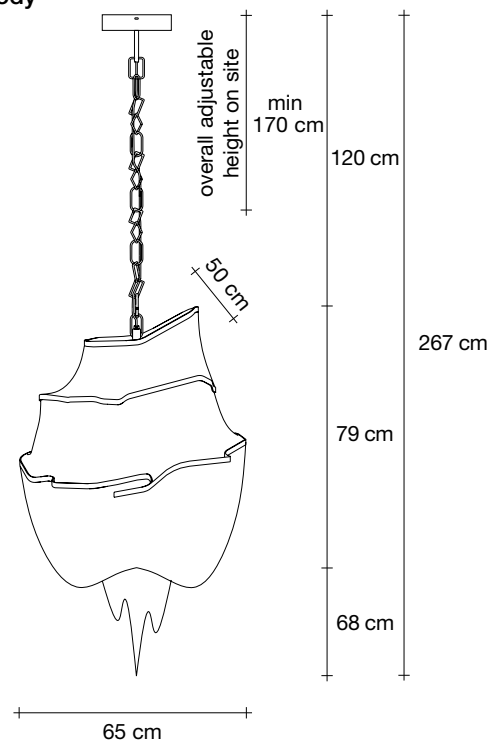

### Light source

220-240V ~ 50/60Hz

 led  
8 x 6W E14 dimmable

dimmable options

 all systems

### Canopy

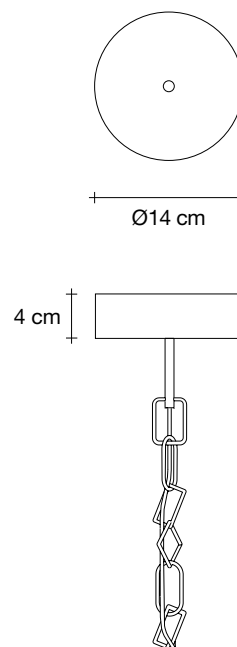

Seemingly alive, Atlantis' shimmering light creates a vibrant source of energy. Its mesmerizing, organic effect is created by hundreds of illuminated lengths of draped chains. Like water in the ocean, Atlantis's chains appear liquid, cascading over its gloss bands and falling down towards the abyss before turning back into itself. Atlantis is composed of almost three miles of chain, meticulously hand-crafted by master Italian artisans. Design Barlas Baylar.

# Atlantis, a precious *wave*.

design Barlas Baylar  
terzani.com

# TERZANI



**Name**  
Atlantis  
large three tier chandelier

**Materials**  
brass chains | metal  
structure plated as below



### Finishes | Code

-  nickel plated  
0A15SE7C8
-  black nickel plated  
0A15SE9C8
-  brushed bronze  
0A15SF7C8
-  gold plated  
0A15SL6C8
-  champagne plated  
0A15SN1C8
-  brushed champagne plated  
0A15SN7C8

### Body

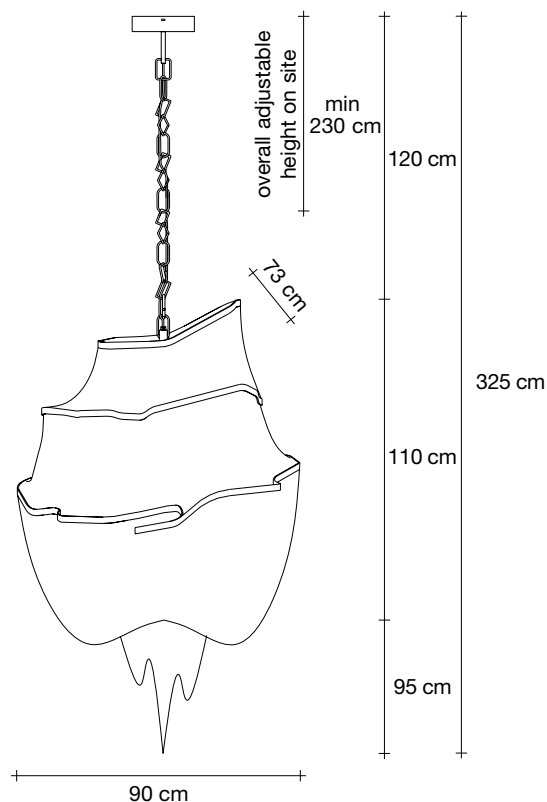

**Light source**  
220-240V ~ 50/60Hz

 led  
8 x 6W E14 dimmable

dimnable options

 all systems

### Canopy

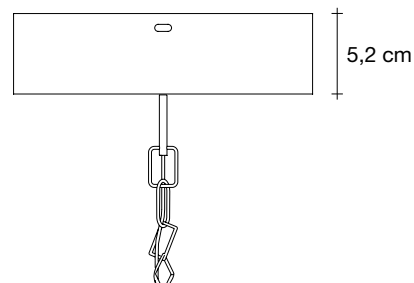
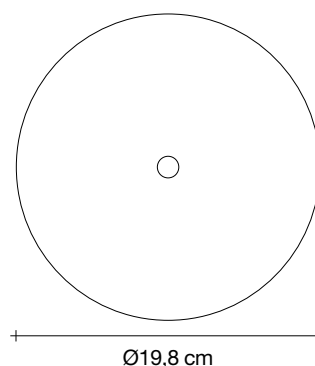

Seemingly alive, Atlantis' shimmering light creates a vibrant source of energy. Its mesmerizing, organic effect is created by hundreds of illuminated lengths of draped chains. Like water in the ocean, Atlantis's chains appear liquid, cascading over its gloss bands and falling down towards the abyss before turning back into itself. Atlantis is composed of almost three miles of chain, meticulously hand-crafted by master Italian artisans. Design Barlas Baylar.

# Atlantis, a precious *wave*.

design Barlas Baylar  
terzani.com

**TERZANI**



**Name**  
Atlantis  
small linear chandelier

**Materials**  
brass chains | metal  
structure plated as below

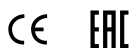

**Finishes | Code**

-  nickel plated  
0A18SE7C8
-  black nickel plated  
0A18SE9C8
-  brushed bronze  
0A18SF7C8
-  gold plated  
0A18SL6C8
-  champagne plated  
0A18SN1C8
-  brushed champagne plated  
0A18SN7C8

**Body**

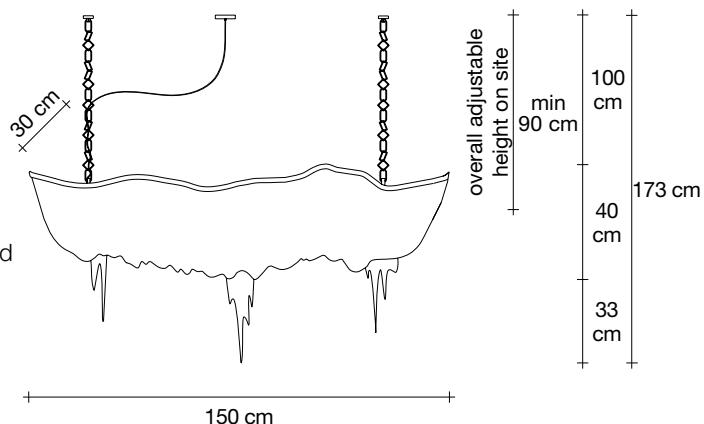

**Light source**

230-240V ~ 50/60Hz

 led  
8 x 6W E14 dimmable

**dimmable options**

 all systems

**Canopy**

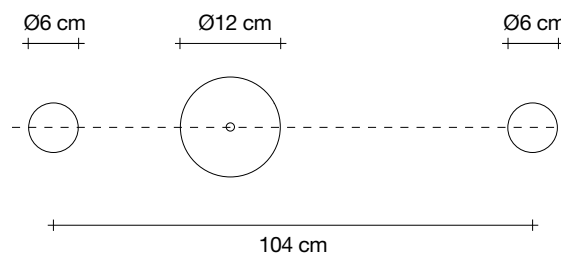

Seemingly alive, Atlantis' shimmering light creates a vibrant source of energy. Its mesmerizing, organic effect is created by hundreds of illuminated lengths of draped chains. Like water in the ocean, Atlantis's chains appear liquid, cascading over its gloss bands and falling down towards the abyss before turning back into itself. Atlantis is composed of almost three miles of chain, meticulously hand-crafted by master Italian artisans. Design Barlas Baylar.

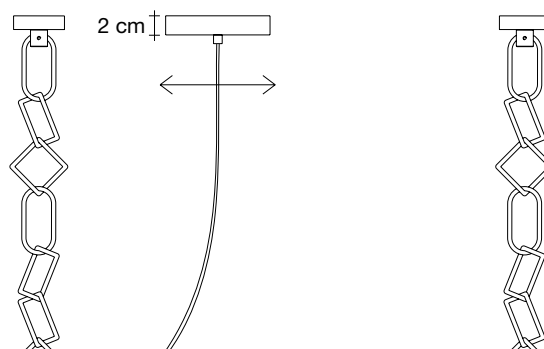

# Atlantis, a precious *wave*.

design Barlas Baylar  
terzani.com

# TERZANI



**Name**  
Atlantis  
medium linear chandelier

**Materials**  
brass chains | metal  
structure plated as below

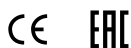

**Finishes | Code**

-  nickel plated  
0A17SE7C8
-  black nickel plated  
0A17SE9C8
-  brushed bronze  
0A17SF7C8
-  gold plated  
0A17SL6C8
-  champagne plated  
0A17SN1C8
-  brushed champagne plated  
0A17SN7C8

**Body**

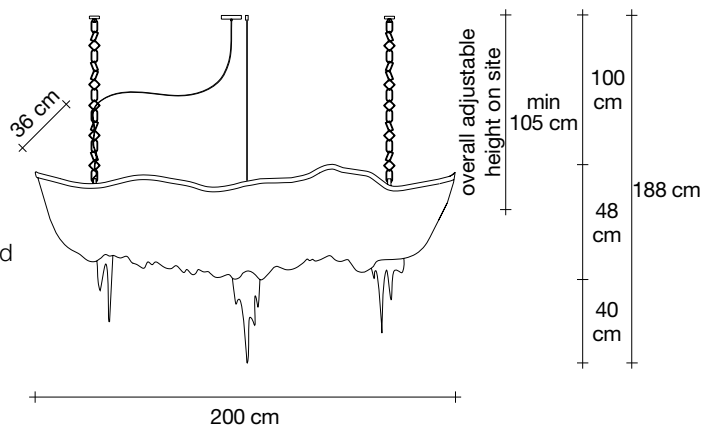

**Light source**  
220-240V ~ 50/60Hz

 led  
10 x 6W E14 dimmable

**dimmable options**

 all systems

**Canopy**

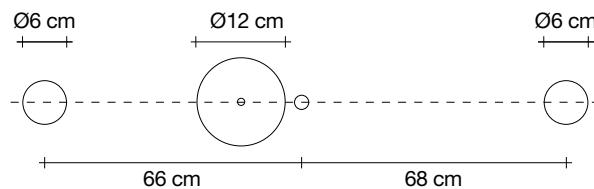

Seemingly alive, Atlantis' shimmering light creates a vibrant source of energy. Its mesmerizing, organic effect is created by hundreds of illuminated lengths of draped chains. Like water in the ocean, Atlantis's chains appear liquid, cascading over its gloss bands and falling down towards the abyss before turning back into itself. Atlantis is composed of almost three miles of chain, meticulously hand-crafted by master Italian artisans. Design Barlas Baylar.

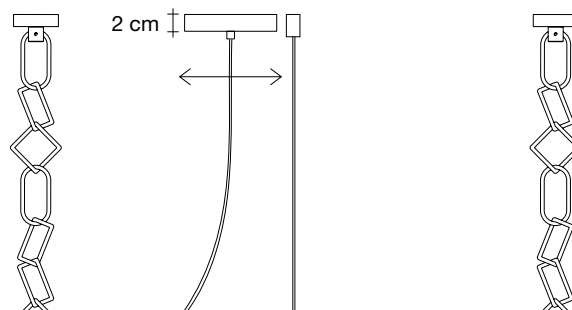

# Atlantis, a precious *wave*.

design Barlas Baylar  
terzani.com

**TERZANI**



**Name**  
Atlantis  
large linear chandelier

**Materials**  
brass chains | metal  
structure plated as below



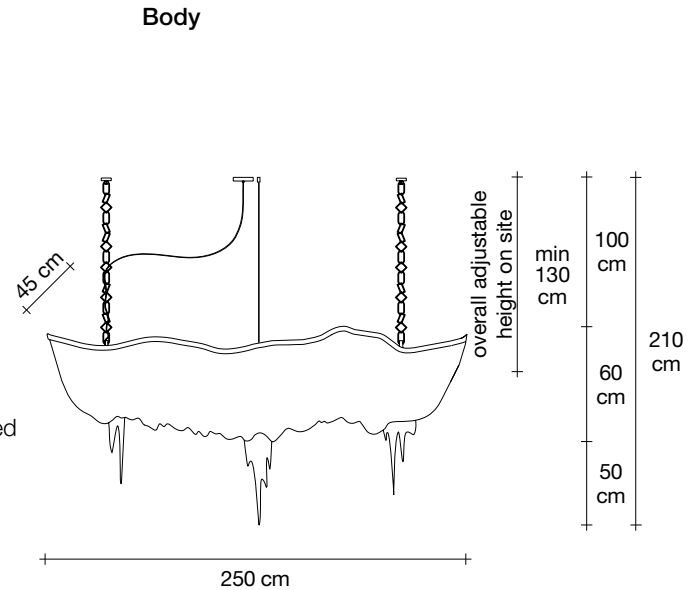

**Finishes | Code**

-  nickel plated  
0A16SE7C8
-  black nickel plated  
0A16SE9C8
-  brushed bronze  
0A16SF7C8
-  gold plated  
0A16SL6C8
-  champagne plated  
0A16SN1C8
-  brushed champagne plated  
0A16SN7C8



**Light source**  
220-240V ~ 50/60Hz

-  led  
10 x 6W E14 dimmable
- dimmable options**
-  all systems

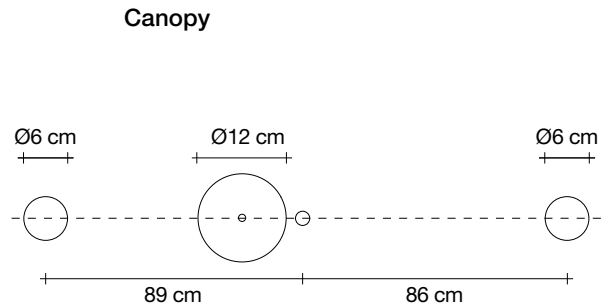

Seemingly alive, Atlantis' shimmering light creates a vibrant source of energy. Its mesmerizing, organic effect is created by hundreds of illuminated lengths of draped chains. Like water in the ocean, Atlantis's chains appear liquid, cascading over its gloss bands and falling down towards the abyss before turning back into itself. Atlantis is composed of almost three miles of chain, meticulously hand-crafted by master Italian artisans. Design Barlas Baylar.

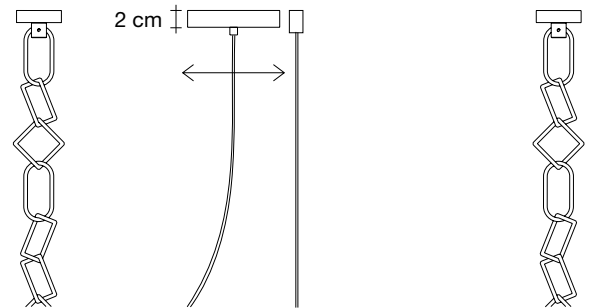

# Atlantis, a precious *wave*.

design Barlas Baylar  
terzani.com

# TERZANI







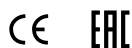

**Name**  
Atlantis  
two tier chandelier

**Materials**  
brass chains | metal  
structure plated as below



### Finishes | Code

-  nickel plated  
OJ01SE7C8
-  black nickel plated  
OJ01SE9C8
-  brushed bronze  
OJ01SF7C8
-  gold plated  
OJ01SL6C8
-  champagne plated  
OJ01SN1C8
-  brushed champagne plated  
OJ01SN7C8

### Body

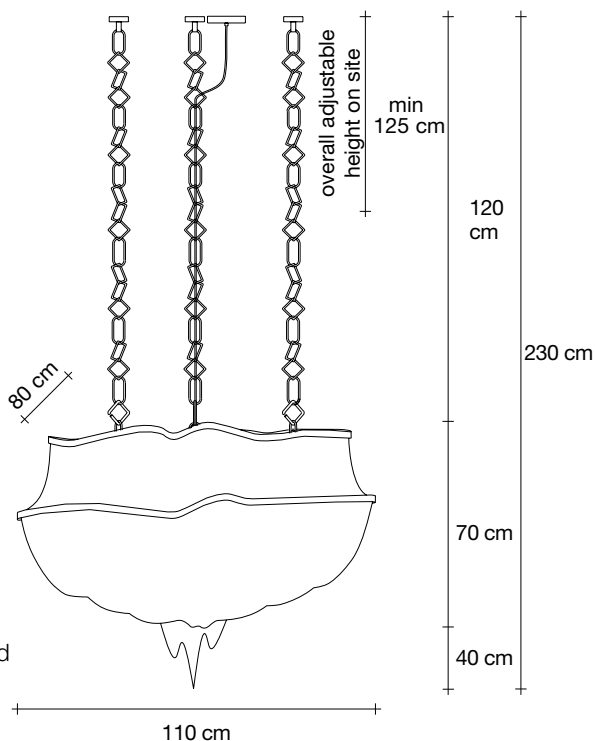

**Light source**  
220-240V ~ 50/60Hz

 led  
8 x 6W E14 dimmable

dimmable options

 all systems

### Canopy

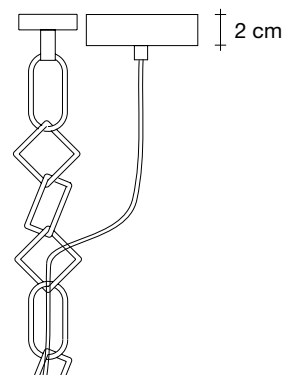
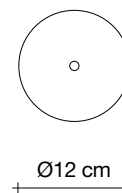

Seemingly alive, Atlantis' shimmering light creates a vibrant source of energy. Its mesmerizing, organic effect is created by hundreds of illuminated lengths of draped chains. Like water in the ocean, Atlantis's chains appear liquid, cascading over its gloss bands and falling down towards the abyss before turning back into itself. Atlantis is composed of almost three miles of chain, meticulously hand-crafted by master Italian artisans. Design Barlas Baylar.

# Atlantis, a precious *wave*.

design Barlas Baylar  
terzani.com

# TERZANI



**Name**  
Atlantis  
small wall sconce

**Materials**  
brass chains | metal  
structure plated as below

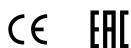

### Finishes | Code

-  nickel plated  
OJ04AE7C8
-  black nickel plated  
OJ04AE9C8
-  brushed bronze  
OJ04AF7C8
-  gold plated  
OJ04AL6C8
-  champagne plated  
OJ04AN1C8
-  brushed champagne plated  
OJ04AN7C8

### Body

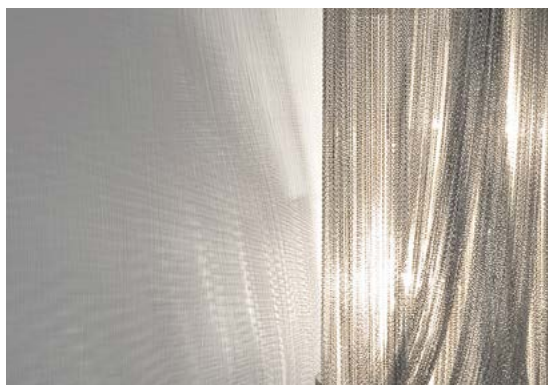
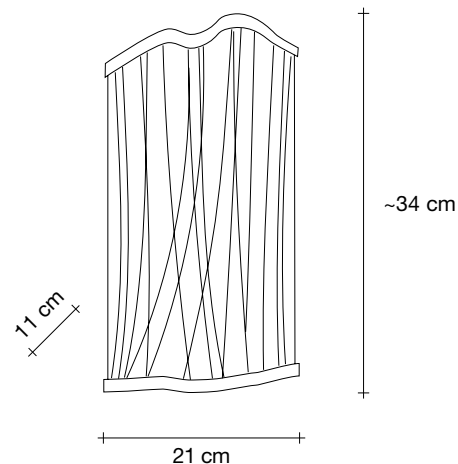

**Light source**  
220-240V ~ 50/60Hz

 led  
2 x 6W E14 dimmable

**dimmable options**

 all systems

### Canopy

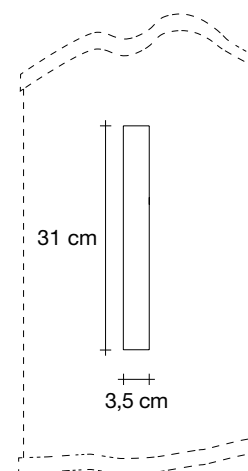

Seemingly alive, Atlantis' shimmering light creates a vibrant source of energy. Its mesmerizing, organic effect is created by hundreds of illuminated lengths of draped chains. Like water in the ocean, Atlantis's chains appear liquid, cascading over its gloss bands and falling down towards the abyss before turning back into itself. Atlantis is composed of almost three miles of chain, meticulously hand-crafted by master Italian artisans. Design Barlas Baylar.

# Atlantis, a precious *wave*.

design Barlas Baylar  
terzani.com

# TERZANI









**Name**  
Atlantis  
large wall sconce

**Materials**  
brass chains | metal  
structure plated as below



### Finishes | Code

-  nickel plated  
OJ03AE7C8
-  black nickel plated  
OJ03AE9C8
-  brushed bronze  
OJ03AF7C8
-  gold plated  
OJ03AL6C8
-  champagne plated  
OJ03AN1C8
-  brushed champagne plated  
OJ03AN7C8

### Body

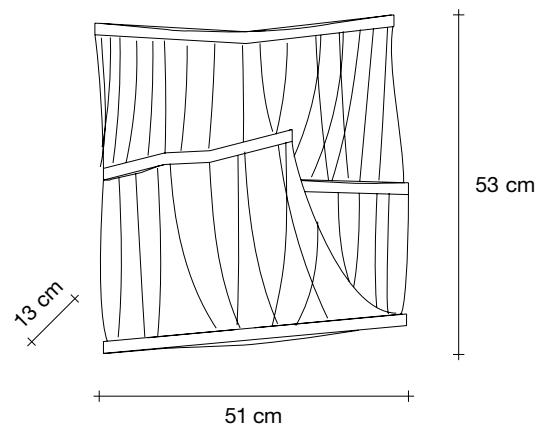

**Light source**  
220-240V ~ 50/60Hz

 led  
4 x 6W E14 dimmable

dimmable options

 all systems

### Canopy

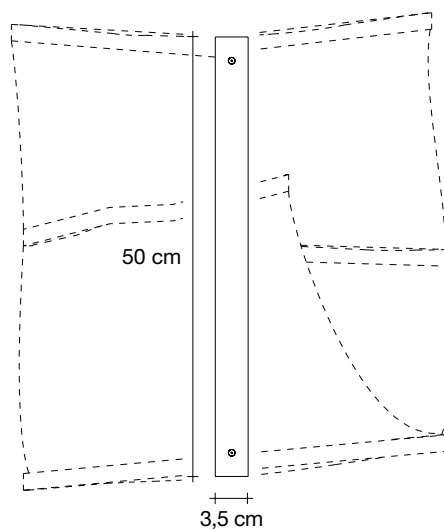

Seemingly alive, Atlantis' shimmering light creates a vibrant source of energy. Its mesmerizing, organic effect is created by hundreds of illuminated lengths of draped chains. Like water in the ocean, Atlantis's chains appear liquid, cascading over its gloss bands and falling down towards the abyss before turning back into itself. Atlantis is composed of almost three miles of chain, meticulously hand-crafted by master Italian artisans. Design Barlas Baylar.