

# Mizu, flowing *light*.

design Nicolas Terzani  
terzani.com



**Product Name**  
Mizu  
3 light pendant

**Materials**  
crystal



**Finishes | Code**

-  clear  
OR03S H4 A9
-  champagne  
OR03S E8 H1
-  cognac  
OR03S E8 H4
-  silver dust  
OR03S H4 F4
-  gold  
OR03S E8 A4

**Body**

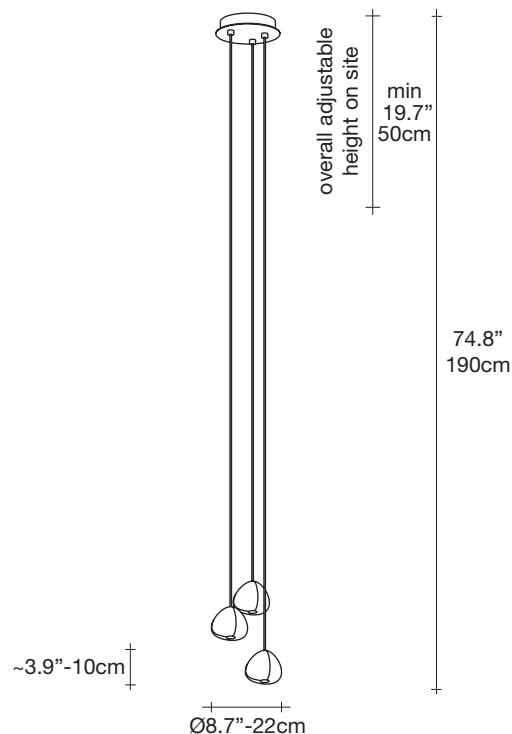

**Light source**

120V ~ 50/60Hz

 XENON  
3 x 10W G4 12V

or

 LED  
3 x 2W G4 12V

dimmable with

 IGBT  
TRIAC

**Canopy | white or brushed nickel**

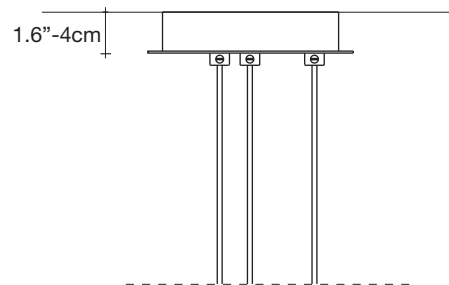
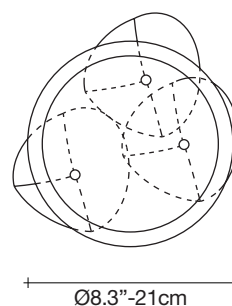

Inspired by the tranquil and mesmerizing light refractions created by water, Mizu is a customizable pendant light from Terzani. Like water droplets, no two Mizu are alike, each crystal shape is unique and made meticulously by hand. Using only the clearest crystal, Mizu perfectly emulates water's refraction of light, casting amazing patterns around the room, reminiscent of flowing water. Also available in gold leaf. Design Nicolas Terzani