

Mizu, flowing light.

design Nicolas Terzani
terzani.com

TERZANI







Name
Mizu
pendant light

Materials
crystal



Finishes | Code

-  clear
OR01SE8A9TG
-  champagne
OR01SE8H1TG
-  cognac
OR01SE8H4TG
-  silver dust
OR01SE8F4TG
-  gold
OR01SE8A4TG

Body

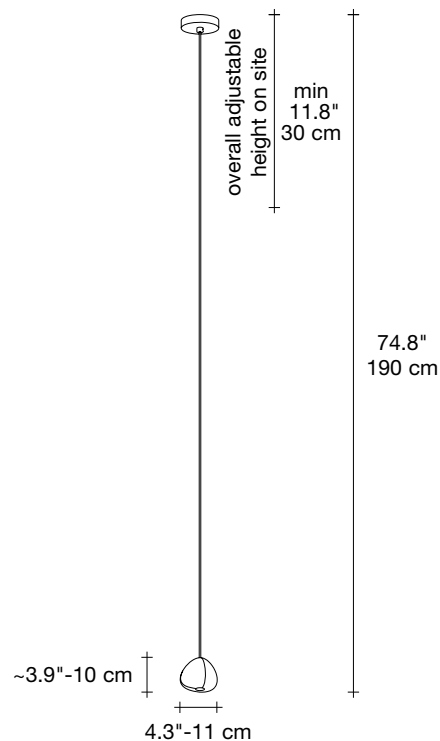

Light source options

120V ~ 50/60Hz

 XENON
10W G4 12V

or

 LED
2W G4 12V

or

 Built in Replaceable LED Module
1,5W 174 lm 3000K
or optional 164 lm 2700K

dimnable options

 not dimmable

 ELV

Canopy | white

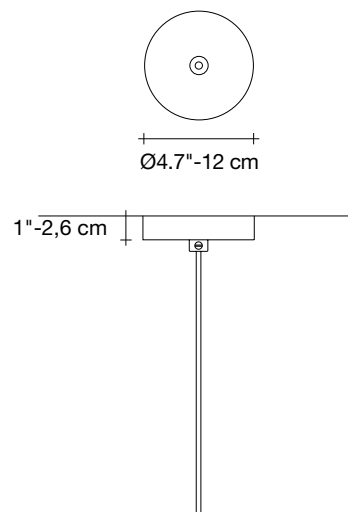

Inspired by the tranquil and mesmerizing light refractions created by water, Mizu is a customizable pendant light from Terzani. Like water droplets, no two Mizu are alike; each crystal shape is unique and meticulously handmade. Using only the clearest crystal, Mizu perfectly emulates water's refraction of light, casting amazing patterns around the room, reminiscent of flowing water. Available in clear, silver dust, gold, cognac, and champagne finish. Design Nicolas Terzani.